

# Middle Size Robot League Rules and Regulations for 2009

Version - 13.1 20081212

MSL Technical Committee 1997–2009

Minoru Asada  
Tucker Balch  
Andrea Bonarini  
Ansgar Bredendfeld  
Steffen Gutmann  
Gerhard Kraetzschmar  
Pedro Lima  
Emanuele Menegatti  
Pieter Jonker  
Alireza Fadaei Tehrani  
Takayuki Nakamura  
Gerald Steinbauer  
Martin Lauer  
Yasunori Takemura  
Huimin Lu

Enrico Pagello  
Fernando Ribeiro  
Thorsten Schmitt  
Wei-Min Shen  
Hans Sprong  
Shoji Suzuki  
Yasutake Takahashi  
Paul G. Ploeger  
Frank Schreiber  
Jürge van Eijck  
Akihiro Matsumoto  
Saeed Shiry Ghidary  
Roel Merry  
Bernardo Cunha  
Darwin Lau

December 12, 2008



## **Disclaimer, Acknowledgements, and Copyright**

This documents reproduces and makes reference to the official Laws of the Game as set forth by FIFA and the International Football Association Board. For clauses reproduced from the official Laws of the Game, the copyright and all rights are reserved by FIFA and the International Football Association Board. For all other parts, in particular the RoboCup Changes and Comments to FIFA Laws, the copyright and all rights are reserved by the RoboCup Federation.

## **Document Status**

This is the draft version (ver. 13.1) of the rules that will be used for the 13th RoboCup Soccer World Championships, to be held in Graz, Austria 2009 and for MSL competitions in 2009.

# Middle Size Robot League – Rules and Regulations –

## Preamble

### Rules Philosophy:

1. RoboCup rules should not in any way describe the behavior of how the game is played. Rules should only ensure that a fair competition takes place, and encourage both technical and creative development.
2. RoboCup rules should avoid to constrain the design of robots, including their mechanical construction, their use of sensory systems, communication equipment, etc., **unless** the constraints seem necessary to foster scientific progress or to ensure a fair competition.  
Example constraint: Global vision systems are not permitted in the middle size league.
3. Teams should avoid to search for gaps or inconsistencies in the rules to achieve advantages in specific game situations. If a team finds such gaps or inconsistencies, they are explicitly requested to report those to the technical committee.

### Design Philosophy:

1. Each team should design their robots without making interpretations or placing expectations on how the environment around the field will look like, about spectators, what other teams will do, what robots should look like, or how they will behave.
2. Each team is under no obligation to accommodate modifications to their own robots to suit other teams. Any such modification is by mutual consent only.

## Organization of Rules:

Rules and regulations for the RoboCup Middle Size robot League are given in two major sections:

1. Official FIFA Laws.  
They are reproduced in this document. FIFA Laws are annotated with RoboCup Changes and Comments as appropriate.
2. Competition Rules, which define issues like team qualification, etc., for a specific tournament like the annual RoboCup Robot Soccer World Championships.

## Conflict Resolution Rules:

In case of any conflict between Laws and Rules:

1. Regulations specified as RoboCup Changes and Comments in the FIFA Laws section override FIFA Laws.
2. Regulations specified in Competition Laws override any FIFA Laws, including RoboCup Changes and Comments.

## Download Sites

The current version of the rules can be downloaded as PDF document at

[www.er.ams.eng.osaka-u.ac.jp/robocup-mid](http://www.er.ams.eng.osaka-u.ac.jp/robocup-mid).

The original FIFA Laws can be found at

[www.er.ams.eng.osaka-u.ac.jp/rc2004msl/LOTG2003\\_e.pdf](http://www.er.ams.eng.osaka-u.ac.jp/rc2004msl/LOTG2003_e.pdf).

## Rule Change Proposals and Corrections

If you have found any contradictions or inconsistencies please contact the RoboCup Middle Size League mailing list

[robocup-mid@robocup.biglist.com](mailto:robocup-mid@robocup.biglist.com),

or the MSL Technical Committee

[rc-msl-tc@er.ams.eng.osaka-u.ac.jp](mailto:rc-msl-tc@er.ams.eng.osaka-u.ac.jp).

For subscription to the RoboCup Middle Size League mailing list please send an email to

[robocup-mid-subscribe@robocup.biglist.com](mailto:robocup-mid-subscribe@robocup.biglist.com).

For unsubscription to the RoboCup Middle Size League mailing list please send an email to

[robocup-mid-unsubscribe@robocup.biglist.com](mailto:robocup-mid-unsubscribe@robocup.biglist.com).

For further information about the RoboCup Middle Size League mailing list please send an email to

[robocup-mid-help@robocup.biglist.com](mailto:robocup-mid-help@robocup.biglist.com).

For general information about BIGLIST mailing lists please see

<http://www.biglist.com/>.

# Contents

FIFA LAW 1 – The Field of Play . . . . .	2
RC-1.0: The Field . . . . .	2
RC-1.0.1: Surface . . . . .	2
RC-1.0.2: Lighting . . . . .	2
FL 1.1 Dimensions . . . . .	2
RC-1.1: Dimensions . . . . .	2
FL 1.2 Field Markings . . . . .	3
RC-1.2: Field Markings . . . . .	3
RC-1.2.1: Safety Boundary . . . . .	3
RC-1.2.2: Ad Panels . . . . .	3
RC-1.2.3: Restart Spots . . . . .	3
FL 1.3 The Goal Area . . . . .	3
RC-1.3: Goal Area . . . . .	3
FL 1.4 The Penalty Area . . . . .	3
RC-1.4: Penalty Area . . . . .	4
FL 1.5 flagposts . . . . .	4
RC-1.5: flagposts . . . . .	4
FL 1.6 The Corner Arc . . . . .	4
RC-1.6: Corner Arc . . . . .	4
FL 1.7 Goals . . . . .	5
RC-1.7: Goals . . . . .	5
FL 1.8 Safety . . . . .	5
Decisions of the International F.A. Board . . . . .	5
RC-Decision 5: . . . . .	6
FIFA LAW 2 – The Ball . . . . .	7
FL 2.1 Qualities and Measurements . . . . .	7
RC-2.1: Qualities and Measurements . . . . .	7
FL 2.2 Replacement of a Defective Ball . . . . .	7
Decisions of the International F.A. Board . . . . .	7
RC-Decision 2: . . . . .	8
FIFA LAW 3 – The Number of Players . . . . .	9
FL 3.1 Players . . . . .	9
RC-3.1: Players . . . . .	9
RC-3.1.1: Incapable Players . . . . .	9
FL 3.2 Official Competitions . . . . .	9
RC-3.2: Official Competitions . . . . .	9
FL 3.3 Other Matches . . . . .	9
FL 3.4 All Matches . . . . .	9
FL 3.5 Substitution Procedure . . . . .	9
FL 3.6 Changing the Goalkeeper . . . . .	10
RC-3.5: Goalie Substitution Procedure . . . . .	10
FL 3.7 Infringements/Sanctions . . . . .	10
FL 3.8 Restart of Play . . . . .	10
FL 3.9 Players and Substitutes Sent Off . . . . .	10
FL 3.10 Decisions of the International F.A. Board . . . . .	11
RC-Decision 2: . . . . .	11

FIFA LAW 4 – The Players’ Equipment . . . . .	12
RC-4.0.1: Design Guideline . . . . .	12
FL 4.1 Safety . . . . .	12
RC-4.1: Safety . . . . .	12
RC-4.1.1: Jamming . . . . .	12
RC-4.1.2: Exclusion . . . . .	12
FL 4.2 Basic Equipment . . . . .	12
RC-4.2.0: Robot Size . . . . .	13
RC-4.2.1: Robot Shape . . . . .	13
RC-4.2.2: Robot Weight . . . . .	13
RC-4.2.3: Robot Colors . . . . .	13
RC-4.2.4: Robot Markers . . . . .	13
RC-4.2.4.1: Color Markers . . . . .	14
RC-4.2.4.2: Number Markers . . . . .	14
RC-4.2.4.3: Top Markers . . . . .	15
RC-4.2.5: Communications . . . . .	16
RC-4.2.6: Sensing Systems . . . . .	18
RC-4.2.7: Ball Handling Mechanisms . . . . .	18
FL 4.3 Shin-guards . . . . .	18
RC-4.3.1: Robustness . . . . .	19
FL 4.4 Goalkeepers . . . . .	19
RC-4.4: Goalkeepers . . . . .	19
FL 4.5 Infringements/Sanctions . . . . .	19
RC-4.5.1: Repair of Robots . . . . .	20
FL 4.6 Restart of Play . . . . .	20
FIFA LAW 5 – The Referee . . . . .	21
FL 5.1 The Authority of the Referee . . . . .	21
FL 5.2 Powers and Duties . . . . .	21
RC-5.3: Powers and Duties . . . . .	21
RC-5.3.1: Referee Box . . . . .	22
RC-5.3.2: Permission to stop the robots . . . . .	22
FL 5.3 Decisions of the Referee . . . . .	22
Decisions of the International F.A. Board . . . . .	22
FIFA LAW 6 – The Assistant Referees . . . . .	24
FL 6.1 Duties . . . . .	24
RC-6.1: Duties . . . . .	24
FL 6.2 Assistance . . . . .	24
FIFA LAW 7 – The Duration of the Match . . . . .	25
FL 7.1 Periods of Play . . . . .	25
RC-7.1: Periods of Play . . . . .	25
FL 7.2 Half-Time Interval . . . . .	25
RC-7.2: Half-Time Interval . . . . .	25
FL 7.3 Allowance for Time Lost . . . . .	25
FL 7.4 Penalty Kick . . . . .	25
FL 7.5 Extra Time . . . . .	25
FL 7.6 Abandoned Match . . . . .	25
FIFA LAW 8 – The Start and Restart of Play . . . . .	26
FL 8.1 Preliminaries . . . . .	26
RC-8.1.1: Start Delay . . . . .	26
RC-8.1.2: Remote Start . . . . .	26
FL 8.2 Kick-off . . . . .	26
FL 8.3 Procedure (for kick-off) . . . . .	26
RC-8.3: Procedure (for Kick-Off) . . . . .	27
RC-8.3.1: Positioning of Robots . . . . .	28
FL 8.4 Infringements/Sanctions (for kick-off) . . . . .	28
RC-8.4.1: Kicking Directly to the goal . . . . .	28
FL 8.5 Dropped Ball . . . . .	28

RC-8.5.1: Game Stuck . . . . .	28
FL 8.6 Procedure (for dropped ball) . . . . .	28
RC-8.6: Procedure (for Dropped Ball) . . . . .	29
FL 8.7 Infringements/Sanctions (for dropped ball) . . . . .	29
RC-8.7: Infringements/ Sanctions . . . . .	29
FL 8.8 Special Circumstances . . . . .	30
FIFA LAW 9 – The Ball In and Out of Play . . . . .	31
FL 9.1 Ball Out of Play . . . . .	31
RC-9.1.1: Dead Call . . . . .	31
RC-9.1.2: Continuation after Dead Call . . . . .	31
FL 9.2 Ball In Play . . . . .	31
FIFA LAW 10 – The Method of Scoring . . . . .	32
FL 10.1 Goal Scored . . . . .	32
FL 10.2 Winning Team . . . . .	32
FL 10.3 Competition Rules . . . . .	32
FIFA LAW 11 – Offside . . . . .	33
RC-11: Offside . . . . .	33
FL 11.1 Offside Position . . . . .	33
FL 11.2 Offence . . . . .	33
FL 11.3 No Offence . . . . .	33
FL 11.4 Infringements/Sanctions . . . . .	33
FIFA LAW 12 – Fouls and Misconduct . . . . .	34
RC-12.0: Ball Manipulation . . . . .	34
FL 12.1 Direct Free Kick . . . . .	35
RC-12.1: Direct Free Kick . . . . .	35
FL 12.2 Penalty Kick . . . . .	35
RC-12.2: Penalty Kick . . . . .	35
FL 12.3 Indirect Free Kick . . . . .	35
RC-12.3: Indirect Free Kick . . . . .	37
RC-12.3.1: Ball Holding . . . . .	37
RC-12.3.2: Pushing . . . . .	38
RC-12.3.3: Kicking . . . . .	38
RC-12.3.4: Illegal Defense . . . . .	39
RC-12.3.5: Illegal Attack . . . . .	39
RC-12.3.6: Manual Interference . . . . .	40
RC-12.3.7: Remote Interference . . . . .	40
RC-12.3.8: Delay Of Game . . . . .	40
RC-12.3.9: Unsportsmanlike Behavior . . . . .	40
RC-12.3.10: Goalie Protection . . . . .	41
RC-12.3.11: Manual Positioning . . . . .	41
FL 12.4 Disciplinary Sanctions . . . . .	41
FL 12.5 Cautionable Offences . . . . .	41
RC-12.5: Cautionable Offences . . . . .	42
RC-12.5.1: Yellow Cards . . . . .	42
FL 12.6 Sending-Off Offences . . . . .	42
RC-12.6: Temporary Sent-Off . . . . .	42
RC-12.6: Sending-Off Offences . . . . .	43
Decisions of the International F.A. Board . . . . .	43
RC-Decision 1-4: . . . . .	43
FIFA LAW 13 – Free Kicks . . . . .	44
FL 13.1 Types of Free Kicks . . . . .	44
RC-13.1.1: Free kicks . . . . .	44
RC-13.1.2: Touching . . . . .	44
FL 13.2 The Direct Free Kick . . . . .	44
FL 13.3 The Indirect Free Kick . . . . .	44
FL 13.4 Position of Free Kick . . . . .	44
RC-13.4: Position of the Free Kick . . . . .	45

RC-13.4.1: Procedure . . . . .	46
FL 13.5 Infringements/Sanctions . . . . .	46
RC-13.5: Infringements/ Sanctions . . . . .	47
FIFA LAW 14 – The Penalty Kick . . . . .	48
FL 14.1 Position of the Ball and the Players . . . . .	48
RC-14.1: Position of Ball and Players . . . . .	48
FL 14.2 The Referee . . . . .	48
RC-14.2: The Referee . . . . .	48
FL 14.3 Procedure . . . . .	49
RC-14.3: Procedure . . . . .	49
FL 14.4 Infringements/Sanctions . . . . .	50
RC-14.4: Infringements/ Sanctions . . . . .	51
FIFA LAW 15 – The Throw-In . . . . .	52
FL 15.1 Procedure (The Throw-In) . . . . .	52
RC-15.1: Procedure . . . . .	53
FL 15.2 Infringements/Sanctions . . . . .	54
RC-15.2: Infringements/ Sanctions . . . . .	54
FIFA LAW 16 – The Goal Kick . . . . .	55
FL 16.1 Procedure (for Goal Kick) . . . . .	55
RC-16.1: Procedure . . . . .	56
FL 16.2 Infringements/Sanctions . . . . .	56
RC-16.2: Infringements/ Sanctions . . . . .	57
FIFA LAW 17 - The Corner Kick . . . . .	58
FL 17.1 Procedure (for Corner Kick) . . . . .	58
RC-17.1: Procedure . . . . .	59
FL 17.2 Infringements/Sanctions . . . . .	60
RC-17.2: Infringements/ Sanctions . . . . .	60
<b>Competition Rules</b> . . . . .	<b>61</b>
COMPETITION RULE 1 - Team Qualification . . . . .	62
CR 1.0 Admissibility of Team Qualification Procedures . . . . .	62
CR 1.1 Team Qualification for RoboCup-2009 . . . . .	62
CR 1.2 Evaluation of the Qualification Material . . . . .	62
Scientific results . . . . .	62
Performance in Past Events . . . . .	63
Team Description Paper/Innovations . . . . .	63
Qualification Video . . . . .	63
Contribution to the RoboCup MSL community . . . . .	63
CR 1.3 Due Date, Submission, and Review of Team Qualification Material . . . . .	63
CR 1.4 Agreement on Open Source Development . . . . .	63
COMPETITION RULE 2 - Referees . . . . .	64
CR 2.1 Selection of Referees . . . . .	64
CR 2.2 Referee Assignment . . . . .	64
CR 2.3 Referees during Match . . . . .	64
CR 2.4 Infringements/Sanctions . . . . .	64
COMPETITION RULE 3 - Tournament Regulations . . . . .	64
CR 3.0 Preliminary Remarks . . . . .	64
CR 3.1 Parts of the Competition . . . . .	65
CR 3.2 Team Registration, Setup, and Technical Inspection . . . . .	65
CR 3.3 Technical Challenge . . . . .	66
CR 3.4 Preliminary Rounds . . . . .	66
CR 3.5 Playoffs . . . . .	66
CR 3.6 Appearance at game start . . . . .	67
CR 3.7 Withdrawal from game . . . . .	67
COMPETITION RULE 4 - Summary of Object Colorings . . . . .	67
COMPETITION RULE 5 - Referee Box . . . . .	67
COMPETITION RULE 6 - Rules Updating Time Out . . . . .	67



<b>F-2000 Challenges</b>	<b>68</b>
Challenge 1 - Ball Control and Planning . . . . .	68
Challenge 2 - Cooperative behavior . . . . .	68
Challenge 3 - Cooperative Mixed-Team Play . . . . .	68
Challenge 4 - Play with an arbitrary FIFA ball . . . . .	68
Challenge 5 - Play on an outside field . . . . .	69
Challenge 6 - Show scientific or engineering achievements . . . . .	69
Challenge 7 - Passing . . . . .	69
<b>Tables</b>	<b>71</b>
A 1 Network Table . . . . .	71



# FIFA Laws and RoboCup Modifications

Official FIFA Laws include:

- FIFA Law 1 - The Field of Play
- FIFA Law 2 - The Ball
- FIFA Law 3 - The Number of Players
- FIFA Law 4 - The Players' Equipment
- FIFA Law 5 - The Referee
- FIFA Law 6 - The Assistant Referees
- FIFA Law 7 - The Duration of the Match
- FIFA Law 8 - The Start and Restart of Play
- FIFA Law 9 - The Ball In and Out of Play
- FIFA Law 10 - The Method of Scoring
- FIFA Law 11 - Offside
- FIFA Law 12 - Fouls and Misconduct
- FIFA Law 13 - Free Kicks
- FIFA Law 14 - The Penalty Kick
- FIFA Law 15 - The Throw-In
- FIFA Law 16 - The Goal Kick
- FIFA Law 17 - The Corner Kick

## FIFA LAW 1 – The Field of Play

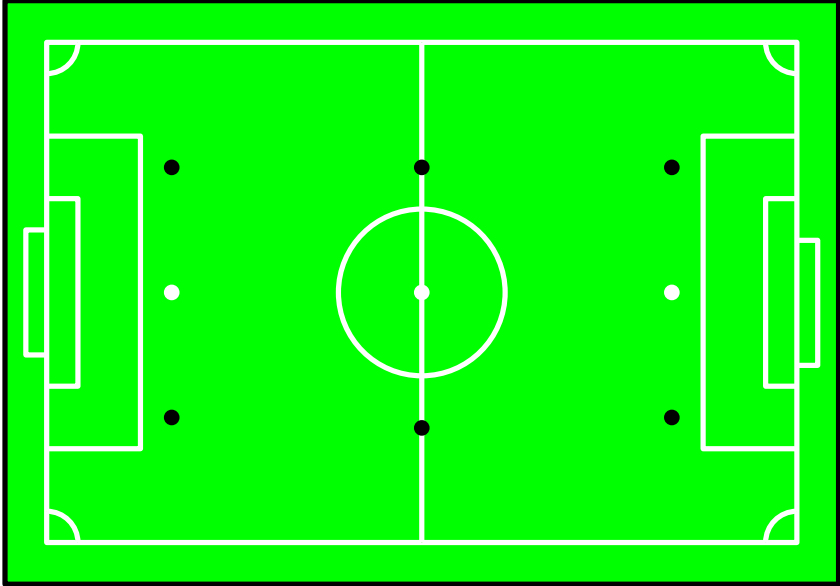
 <b>RoboCup Changes and Comments</b>	
<b>RC-1.0: The Field</b>	
	Attention: The above image doesn't show correct proportions!
<b>RC-1.0.1: Surface</b>	Choosing a material for the floor is the responsibility of the local organizers of an event. The color of the field surface must be green.
<b>RC-1.0.2: Lighting</b>	Artificial light sources may be hung over the field.

### FL 1.1 Dimensions

The field of play must be rectangular. The length of the touch line must be greater than the length of the goal line.

#### National Matches

Length: minimum 90m (100yds), maximum 120m (130yds)

Width: minimum 45m (50yds), maximum 90m (100yds)

#### International Matches

Length: minimum 100m (110yds), maximum 110m (120yds)

Width: minimum 64m (70yds), maximum 75m (80yds)

 <b>RoboCup Changes and Comments</b>	
<b>RC-1.1: Dimensions</b>	<b>RoboCup Matches</b>  Length: minimum 8m, maximum 18m. Width: minimum 6m, maximum 12m. The official field size for this year is 18m × 12m.

### FL 1.2 Field Markings

The field of play is marked with lines. These lines belong to the areas of which they are boundaries. The two longer boundary lines are called touch lines. The two shorter lines are called goal lines. All lines are not more than 12.5cm (5ins) wide. The field of play is divided into two halves by a halfway line. The center mark is indicated at the midpoint of the halfway line. A circle with a radius of 9.15m (10yds) is marked around it.

 <b>RoboCup Changes and Comments</b>	
<b>RC-1.2: Field Markings</b>	The width of touch and goal lines is 12.5cm. The radius of the center circle is 2m. For RoboCup, the width of all internal lines, like center circle, goal area, and penalty area, is also 12.5cm.
<b>RC-1.2.1: Safety Boundary</b>	The field is surrounded by a black safety boundary, the height of which is between 5cm and 15cm. It is placed 1m outside of each field border. The only purpose for this boundary is to prevent robots from running into the audience. All teams are expected to make no assumptions about this boundary. Thus the above constraints might be changed by the organizer within their limits without prior notice.
<b>RC-1.2.2: Ad Panels</b>	The organizers may place ad panels. The length of a panel may not exceed 150 cm and the height may not exceed 50 cm. Panels must be placed on top or outside of the safety boundary. The ad panels are not intended for localization.
<b>RC-1.2.3: Restart Spots</b>	<p>The RoboCup field defines 9 places used for game restart. In addition to the white center marking and the white penalty marks, there are 6 extra spots on the field, optionally marked with black color, which will be used for this purpose. The positions of the extra markers (see field drawing above) are specified as follows:</p> <ul style="list-style-type: none"> <li>• 2 spots on the center line, one each halfway between touch line and center mark.</li> <li>• 2 spots each on a line parallel to the goal line through each penalty mark, one each halfway between touch line and the penalty mark.</li> </ul> <p>The penalty marks are not used for game restarts, unless a penalty was called by the referee. The diameter of the center mark, white penalty marks, and extra spots is 10cm.</p>

### FL 1.3 The Goal Area

A goal area is defined at each end of the field as follows:

Two lines are drawn at right angles to the goal line, 5.5m (6yds) from the inside of each goalpost. These lines extend into the field of play for a distance of 5.5m (6yds) and are joined by a line drawn parallel with the goal line. The area bounded by these lines and the goal line is the goal area.

 <b>RoboCup Changes and Comments</b>	
<b>RC-1.3: Goal Area</b>	For RoboCup, replace “5.5m” by “0.75m”.

### FL 1.4 The Penalty Area

A penalty area is defined at each end of the field as follows:

1. Two lines are drawn at right angles to the goal line, 16.5m (18yds) from the inside of each goalpost. These lines extend into the field of play for a distance of 16.5m (18yds) and are joined by a line

drawn parallel with the goal line. The area bounded by these lines and the goal line is the penalty area.

2. Within each penalty area a penalty mark is made 11m (12yds) from the midpoint between the goalposts and equidistant to them. An arc of a circle with a radius of 9.15m (10yds) from each penalty mark is drawn outside the penalty area.

 <b>RoboCup Changes and Comments</b>	
<b>RC-1.4: Penalty Area</b>	For RoboCup, replace “16.5m” by “ <b>2.25m</b> ”, and “11m” by “ <b>3m</b> ”. In RoboCup, the penalty spot is outside the penalty area. No circle arc is used in RoboCup.

### FL 1.5 flagposts

A flagpost, not less than 1.5m (5ft) high, with a non-pointed top and a flag is placed at each corner. flagposts may also be placed at each end of the halfway line, not less than 1m (1yd) outside the touch line.

 <b>RoboCup Changes and Comments</b>	
<b>RC-1.5: flagposts</b>	No flagposts are currently used in RoboCup.

### FL 1.6 The Corner Arc

A quarter circle line with a radius of 1m (1yd) from each corner flagpost is drawn inside the field of play.

 <b>RoboCup Changes and Comments</b>	
<b>RC-1.6: Corner Arc</b>	For RoboCup, replace “1m” with “ <b>0.75m</b> ”.

**FL 1.7 Goals**

Goals must be placed on the center of each goal line. They consist of two upright posts equidistant from the corner flagposts and joined at the top by a horizontal crossbar. The distance between the posts is 7.32m (8yds) and the distance from the lower edge of the crossbar to the ground is 2.44m (8ft).

Both goalposts and the crossbar have the same width and depth which do not exceed 12.5cm (5ins). The goal lines are the same width as that of the goalposts and the crossbar. Nets may be attached to the goals and the ground behind the goal, provided that they are properly supported and do not interfere with the goalkeeper.

The goalposts and crossbars must be white.

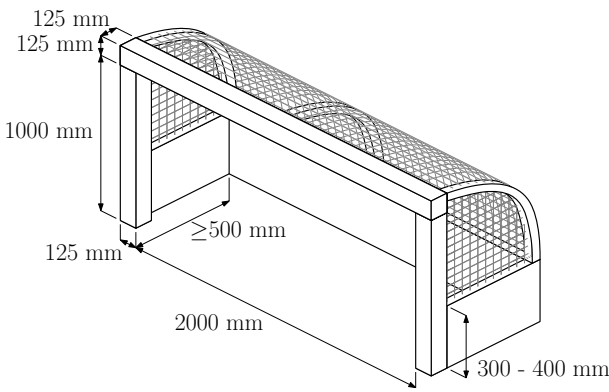
	<p><b>RoboCup Changes and Comments</b></p>
<p><b>RC-1.7: Goals</b></p>	<p>For RoboCup, replace “7.32m” with “2m” and “2.44m” with “1m”. A net is spawn between the crossbar and goal posts to the safety boundary of the field. To avoid direct contact of the net with parts of the robots (wheels, kicking device, etc.), the lower part of the net can be covered over a height between 30 and 40cm as a safety zone. This safety zone has to be done by the local organizer and may vary in each tournament. The depth of the goal is at least 0.5m. The goalposts and the crossbar are painted white. See also COMPETITION RULE 4 for color samples.</p> 

**FL 1.8 Safety**

Goals must be anchored securely to the ground. Portable goals may only be used if they satisfy this requirement.

**Decisions of the International F.A. Board**

**Decision 1:** If the crossbar becomes displaced or broken, play is stopped until it has been repaired or replaced in position. If a repair is not possible, the match is abandoned. The use of a rope to replace the crossbar is not permitted. If the crossbar can be repaired, the match is restarted with a dropped ball at the place where the ball was located when play was stopped (see FIFA LAW 8).

**Decision 2:** Goalposts and crossbars must be made of wood, metal or other approved material. Their shape may be square, rectangular, round or elliptical and they must not be dangerous to players.

**Decision 3:** No kind of commercial advertising, whether real or virtual, is permitted on the field of play and field equipment (including the goal nets and the areas they enclose) from the time the teams enter the field of play until they have left it at half-time and from the time the teams re-enter the

field of play until the end of the match. In particular, no advertising material of any kind may be displayed on goals, nets, flagposts or their flags. No extraneous equipment (cameras, microphones, etc.) may be attached to these items.

**Decision 4:** The reproduction, whether real or virtual, of representative logos or emblems of FIFA, confederations, national associations, leagues, clubs or other bodies, is forbidden on the field of play and field equipment (including the goal nets and the areas they enclose) during playing time, as described in Decision 3.

**Decision 5:** A mark may be made off the field of play, 9.15 meters (10 yds) from the corner arc and at right angles to the goal lines to ensure that this distance is observed when a corner kick is being taken.

 <b>RoboCup</b>	<b>RoboCup Changes and Comments</b>
<b>RC-Decision 5:</b>	FIFA Decision 5 applies with 1m and 2m distances in RoboCup.



## FIFA LAW 2 – The Ball

### FL 2.1 Qualities and Measurements

The ball is

- spherical,
- made of leather or other suitable material,
- of a circumference of not more than 70cm (28ins) and not less than 68cm (27ins),
- not more than 450g (16oz) in weight and not less than 410g (14oz) at the start of the match,
- of a pressure equal to 0.6–1.1 atmosphere (600 - 1100g/cm<sup>2</sup>) at sea level (8.5lbs/sqin – 15.6 lbs/sqin).

	RoboCup Changes and Comments
<b>RC-2.1: Qualities and Measurements</b>	Each team has to be able to play with any orange FIFA standard size 5 football at any time. There will be no specific official ball and the vision system of the robots has to be robust enough to handle any above mentioned ball without recalibration. The ball should not be worn down too much and both team leaders have to find an agreement before a match about which ball they want to use. Else the referee decides about the ball.

### FL 2.2 Replacement of a Defective Ball

If the ball bursts or becomes defective during the course of a match:

- The match is stopped.
- The match is restarted by dropping the replacement ball at the place where the first ball became defective (see FIFA LAW 8).

If the ball bursts or becomes defective whilst not in play at a kick-off, goal kick, corner kick, free kick, penalty kick or throw-in:

- The match is restarted accordingly.

The ball may not be changed during the match without the authority of the referee.

### Decisions of the International F.A. Board

**Decision 1:** In competition matches, only footballs which meet the minimum technical requirements stipulated in FIFA LAW 2) are permitted for use. In FIFA competition matches, and in competition matches organized under the auspices of the confederations, acceptance of a football for use is conditional upon the football bearing one of the following three designations: The official "FIFA APPROVED" logo, or the official "FIFA INSPECTED" logo, or the reference "INTERNATIONAL MATCHBALL STANDARD". Such a designation on a football indicates that it has been tested officially and found to be in compliance with specific technical requirements, different for each category and additional to the minimum specifications stipulated in FIFA LAW 2). The list of the additional requirements specific to each of the respective categories must be approved by the International F.A. Board. The institutes conducting the tests are subject to the approval of FIFA. National association competitions may require the use of balls bearing any one of these three designations. In all other matches the ball used must satisfy the requirements of FIFA LAW 2.

**Decision 2:** In FIFA competition matches and in competition matches organized under the auspices of the confederations and national associations, no kind of commercial advertising on the ball is permitted, except for the emblem of the competition, the competition organizer and the authorized

trademark of the manufacturer. The competition regulations may restrict the size and number of such markings.

 <b>RoboCup</b>	<b>RoboCup Changes and Comments</b>
<b>RC-Decision 2:</b>	The organizing committee of a tournament is responsible for approving the balls to be used, including any kind of advertisement, logo, or emblem on the ball.

## FIFA LAW 3 – The Number of Players

### FL 3.1 Players

A match is played by two teams, each consisting of not more than eleven players, one of whom is the goalkeeper. A match may not start if either team consists of fewer than seven players.

	RoboCup Changes and Comments
<b>RC-3.1: Players</b>	<p>A match is played by two teams, each consisting of not more than five players, one of whom is the goalkeeper.</p> <p>A match may not start if either team consists of fewer than two players. If the number of players of a teams falls under 2 during a match, then the match will still continue.</p>
<b>RC-3.1.1: Incapable Players</b>	<p>Players not capable of play, e.g. players not able to move, or players with defective or malfunctioning sensing and/or actuating systems, are not permitted to participate in the game. It is up to the referee to judge whether a player is capable of play. The referee may ask the team leader of a player suspected to be incapable of play to demonstrate playing ability at any time, in particular before and after a game, during halftime, and during any stoppage of the game.</p>

### FL 3.2 Official Competitions

Up to a maximum of three substitutes may be used in any match played in an official competition organized under the auspices of FIFA, the confederations or the national associations. The rules of the competition must state how many substitutes may be nominated, from three up to a maximum of seven.

	RoboCup Changes and Comments
<b>RC-3.2: Official Competitions</b>	<p>In RoboCup currently no substitutions are used.</p>

### FL 3.3 Other Matches

In other matches, up to five substitutes may be used, provided that:

- The teams concerned reach agreement on a maximum number.
- The referee is informed before the match.

If the referee is not informed, or if no agreement is reached before the start of the match, no more than three substitutes are allowed.

### FL 3.4 All Matches

In all matches the names of the substitutes must be given to the referee prior to the start of the match. Substitutes not so named may not take part in the match.

### FL 3.5 Substitution Procedure

To replace a player by a substitute, the following conditions must be observed:

- The referee is informed before any proposed substitution is made.
- A substitute only enters the field of play after the player being replaced has left and after receiving a signal from the referee.

- A substitute only enters the field of play at the halfway line and during a stoppage in the match.
- A substitution is completed when a substitute enters the field of play.
- From that moment, the substitute becomes a player and the player he has replaced ceases to be a player.
- A player who has been replaced takes no further part in the match.
- All substitutes are subject to the authority and jurisdiction of the referee, whether called upon to play or not.

### FL 3.6 Changing the Goalkeeper

Any of the other players may change places with the goalkeeper, provided that:

- The referee is informed before the change is made.
- The change is made during a stoppage in the match.

 <b>RoboCup Changes and Comments</b>	
<b>RC-3.5: Goalie Substitution Procedure</b>	In RoboCup it is allowed to exchange the goalie with a field player. This has to be done during a break of the game, usually when the goalie is taken from the field for repair.

### FL 3.7 Infringements/Sanctions

If a substitute enters the field of play without the referee's permission:

- Play is stopped.
- The substitute is cautioned, shown the yellow card and required to leave the field of play.
- Play is restarted with a dropped ball at the place it was located when play was stopped (see FIFA LAW 8).

If a player changes places with the goalkeeper without the referee's permission before the change is made:

- Play continues.
- The players concerned are cautioned and shown the yellow card when the ball is next out of play.

For any other infringements of this Law:

- The players concerned are cautioned and shown the yellow card.

### FL 3.8 Restart of Play

If play is stopped by the referee to administer a caution:

- The match is restarted by an indirect free kick, to be taken by a player of the opposing team from the place where the ball was located when play was stopped (see FIFA LAW 8).

### FL 3.9 Players and Substitutes Sent Off

A player who has been sent off before the kick-off may be replaced only by one of the named substitutes. A named substitute who has been sent off, either before the kick-off or after play has started, may not be replaced.

**FL 3.10 Decisions of the International F.A. Board**

**Decision 1:** Subject to the overriding conditions of FIFA LAW 3, the minimum number of players in a team is left to the discretion of national associations. The Board is of the opinion, however, that a match should not continue if there are fewer than seven players in either team.

**Decision 2:** The coach may convey tactical instructions to the players during the match. He and the other officials must remain within the confines of the technical area, where such an area is provided, and they must behave in a responsible manner.

 <b>RoboCup</b>	<b>RoboCup Changes and Comments</b>
<b>RC-Decision 2:</b>	RoboCup players must play autonomously. Coaching and any kind of human interference with robots, with or without technical means, is not allowed, except where otherwise specified in the Laws. Coaching and human interference is only allowed for substitutes and robots outside of the playground, and only if the robots are inactive, in particular, if they do not send any kind of signals, including wireless communications.

## FIFA LAW 4 – The Players’ Equipment

 <b>RoboCup Changes and Comments</b>	
<b>RC-4.0.1: Design Guideline</b>	Robots for playing soccer must be designed such that they are <b>both robust and safe</b> . Both terms are subsequently explained. To support the TC during the verification of the robot size and of the ball manipulation devices, the adequate measurements (e.g. construction plans, etc.) of the robots have to be published before the tournaments. This is regulated in more detail during the qualification process of a tournament.

### FL 4.1 Safety

A player must not use equipment or wear anything which is dangerous to himself or another player (including any kind of jewellery).

 <b>RoboCup Changes and Comments</b>	
<b>RC-4.1: Safety</b>	Robot soccer players must be built such that they are <b>safe</b> . Safe means that robots do not damage other robots or any objects of the playground, or pose a threat to the audience, or to the referees, or to human team members. In particular, <b>the design of the robots should ensure that “Fouls and Misconduct”</b> are avoided. Anyone is allowed to take whatever action that seems necessary to prevent a robot from causing urgent danger. This includes lifting the robot and/or switching it off. Teams must provide an emergency stop button on their robot that interrupts all actuation.
<b>RC-4.1.1: Jamming</b>	Robots must be designed and programmed such that they try to avoid interference concerning the operation of sensor systems and/or communication devices. The use of particular equipment which may cause interference of communication and/or sensors must be reported to the league organizing committee of a tournament and eventually negotiated between two teams before a match. If a team uses communications and sensors other than those previously declared to the tournament committee and/or the opponent, the game may be forfeited, and the league organizing committee may exclude the robots from further participation.
<b>RC-4.1.2: Exclusion</b>	Robots that violate the above conditions, in particular if they threaten to seriously damage opponents or pose a threat to the audience and/or referees and/or human team members, may be excluded from play in a tournament by the league organizing committee.

### FL 4.2 Basic Equipment

The basic compulsory equipment of a player is:

- a jersey or shirt,
- shorts - if thermal undershorts are worn, they are of the same main color as the shorts,
- stockings,
- shin-guards,
- footwear.

	RoboCup Changes and Comments
<b>RC-4.2.0: Robot Size</b>	<p>The size of each robot player must obey the following constraints:</p> <ol style="list-style-type: none"> <li>1. Each robot must possess a configuration of itself and its actuators, where the projection of the robot's shape onto the floor fits into a square of size at least 30cm × 30cm and at most 50cm × 50cm.</li> <li>2. The usual field player has to keep at any time the size limit of 50cm × 50cm.</li> <li>3. The goalie is allowed to increase his size instantaneously (at most 1 second) up to 60cm × 60cm width or 90cm height if the goal is endangered by an approaching ball. The goalie resolves on this situation by itself, but he is only allowed to increase his size again after a pause of 4 seconds and having completely reduced his size to the normal state before the increase. Additionally, it is only allowed to increase its size instantaneously in one direction (left, right or upwards).</li> <li>4. The robot's height must be at least 40 cm and at most 80 cm (exception goalie: 90 cm during extended phase).</li> <li>5. The field players may never exceed the 80 cm height limit.</li> </ol>
<b>RC-4.2.1: Robot Shape</b>	<p>Any shape is allowed as long as the size restrictions are not violated. Robots may exhibit concavities in their shape or may dynamically change shape, provided that the Laws concerning Fouls and Misconduct are not violated.</p>
<b>RC-4.2.2: Robot Weight</b>	<p>The maximum weight of a robot is 40 kg.</p>
<b>RC-4.2.3: Robot Colors</b>	<p>The base color of a robot's body must be black. The paint or used material must be <b>matte</b> in order to minimize reflectivity.</p> <p><b>Note 1:</b> This law does not mean that your robot must be completely black; for example, one cannot paint the lens of a camera. However, every team is expected to try hard to hide non-black parts of the robot as much as possible, especially parts that have colors used for the ball or the field of play.</p> <p><b>Note 2:</b> Teams should avoid using any kind of shiny material for robot surfaces. The league committee may exclude robots that do not conform with coloring laws.</p>
<b>RC-4.2.4: Robot Markers</b>	<p>A robot must have markings in order to be recognized by other robots and to be distinguished by the referee. Each robot must carry color markers, number markers, and top markers. Robots not carrying all markers <b>are not eligible to play</b>.</p>

 <b>RoboCup</b>	<b>RoboCup Changes and Comments</b>
<b>RC-4.2.4.1: Color Markers</b>	<p>Color markers should be designed as follows:</p> <ul style="list-style-type: none"> <li>• Above 30cm and below 60cm, color markers must be present and visible from all sides.</li> <li>• A color marker can be any shape.</li> <li>• The height and width of a color marker must be greater than or equal to 10 cm in any direction.</li> <li>• The marker color must be one of the two predetermined official colors. The official colors are magenta and cyan.</li> </ul> <p>Please use the colors defined by the RAL codes in the competition rule 4. It is the responsibility of team leaders to obtain samples of marker colors and to ensure that their team color markers are as close as possible to the official colors. The Middle Size League Technical Committee may request to build new color markers on site, if the team's color markers do not sufficiently comply with the official colors.</p> <ul style="list-style-type: none"> <li>• Every team must provide the markers in each team color and attach one of them prior to each game.</li> <li>• See also Competition-rules 4, for color examples.</li> </ul>
<b>RC-4.2.4.2: Number Markers</b>	<p>A number marking should be designed as follows:</p> <ul style="list-style-type: none"> <li>• Each robot must carry a number (consisting of two digits at most), in black digits of height no smaller than 8 cm.</li> <li>• The number will be fixed on the color markers and must at least be visible from all four major sides (front, back, left and right) of the robot.</li> <li>• The number 1 is reserved for goal keepers.</li> <li>• The number marking must be easily visible for the referee, other humans and robots from all sides.</li> </ul>

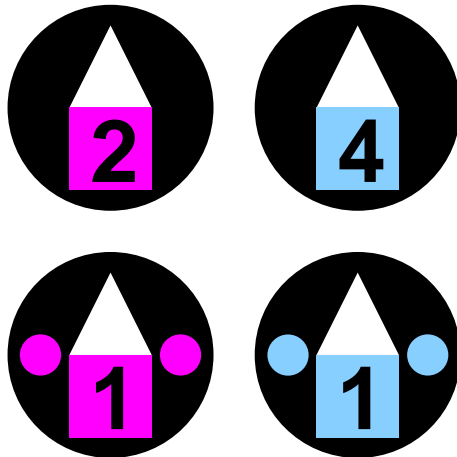

 <b>RoboCup Changes and Comments</b>	
<p><b>RC-4.2.4.3: Top Markers</b></p>	<p>Each robot must carry a top marker as follows (see figure below):</p> <ul style="list-style-type: none"> <li>• The top marker is a black circle with a diameter of 20cm.</li> <li>• On one half of the circle, a square in the respective team color and of at least 8cm side length must be present.</li> <li>• On top the colored square a robot’s number marker must be present.</li> <li>• On the other half of the circle must be a white triangle of side length 8cm, with one side going through the center of the black circle and the opposite edge pointing into the preferred forward movement direction of the robot. For robots with omni-directional drives, the triangle should point into the direction of a kicking device, if present.</li> <li>• The top markers of goal keepers carry two additional circles of 4cm diameter in the respective team color, and located as indicated in the figure.</li> </ul> <div style="text-align: center;">  </div>

	RoboCup Changes and Comments
<p><b>RC-4.2.5: Communications</b></p>	<p>Communication between the robots of a team using wireless links is allowed according to the following rules.</p> <p>Communication between the robots and one remote computer system (herein after referred as Base Station) is also allowed, provided that human interference is excluded. Robots may receive data or commands from this remote computer, as long as these does not include any further information gained by non-robot sensors (e.g. position of the robot itself, or teammates, or opponents, or the ball on the field). It is especially allowed to fuse data on the external computer, if that data is gained only by robots.</p> <p>Wireless communication equipment satisfying IEEE 802.11a and/or IEEE 802.11b specifications is allowed. Use of any other kind of wireless communications using these or other frequencies is explicitly forbidden.</p> <p>All communications between robots, as well as between robots and the Base Station, must be established through one of the two Access Points available at the field of game (either in 'a' or in 'b' mode), and provided by the organization. Use of ad hoc wireless networking is strictly forbidden.</p> <p>Teams may use either unicast or multicast wireless communication modes. Use of broadcast is strictly forbidden.</p> <p>Unicast and IPv4 multicast IP addresses are defined for each team in these rules (see bellow). Teams may not use any IP addresses other than those assigned to them.</p> <p>Although robots may send arbitrary kinds and amounts of data between each other and the Base Station, bandwidth restrictions will apply in order to assure a fair game.</p> <p>All competing teams should have the same network limits, whichever IEEE 802.11 mode is being used. This way, the slower mode (IEEE 802.11b specification) is the one that actually limits the amount of data that can be transmitted. Each team is then allowed to use, at most, 20% of the bandwidth provided by the IEEE 802.11b Access Point. Therefore, 2.2 Megabits/second is the actual maximum bit rate that can be used by any team during the tournament.</p> <p>Apart from the communication equipment placed in the robots, no other team computers or equipment may use any form of wireless communication. In particular, it is mandatory that the team's Base Station Computer has its wireless support turned off.</p> <p>No Access Points, other than those provided by the organization, may be turned on during the tournament.</p> <p>Each team has to provide, together with other team qualification materials, a list of all MAC addresses they intend to use during the tournament, with explicit indication of those that will be used for wireless communication.</p> <p><b>Competition setup</b></p> <p>Each field of the competition will be equipped with the following base elements provided by the organization:</p> <ul style="list-style-type: none"> <li>• Two Access Points. One working in IEEE 802.11a and other working in IEEE 802.11b. These Access Points may or may not be included in a single piece of equipment.</li> <li>• One computer for running the Referee Box software</li> <li>• One computer for running the Network Monitor software</li> <li>• Two LCD screens for Base Station visualization. As defined elsewhere, Base Station laptops must have their covers closed during the entire game.</li> </ul> <p>Both Access Points will connect to a wired network by means of one or two switches.</p>



**RoboCup Changes and Comments**

**RC-4.2.5:  
Communications**

Both the Referee Box, the Network Monitor and the team Base Stations must also be connected by cable to the wired network.

Each team has to design their software in such a way that it is possible for them to use only one Base Station to manage a game.

Commands from the Referee Box will be sent to the team’s Base Station using the wired connection. It is the team responsibility to re-send these commands to their robots on the field.

Network settings, during the competition, will be as follows:

- WEP encryption is turned off.
- Broadcast of SSID is turned on.
- Subnet mask normal PC: 255.255.255.0.
- Subnet mask of a PC connected to the Refbox: 255.255.0.0.
- Access Point Beacon Interval should be set to 20-30.
- Access Point DTIM Interval should be set to 2-3.
- Access Point power save mode is disabled.

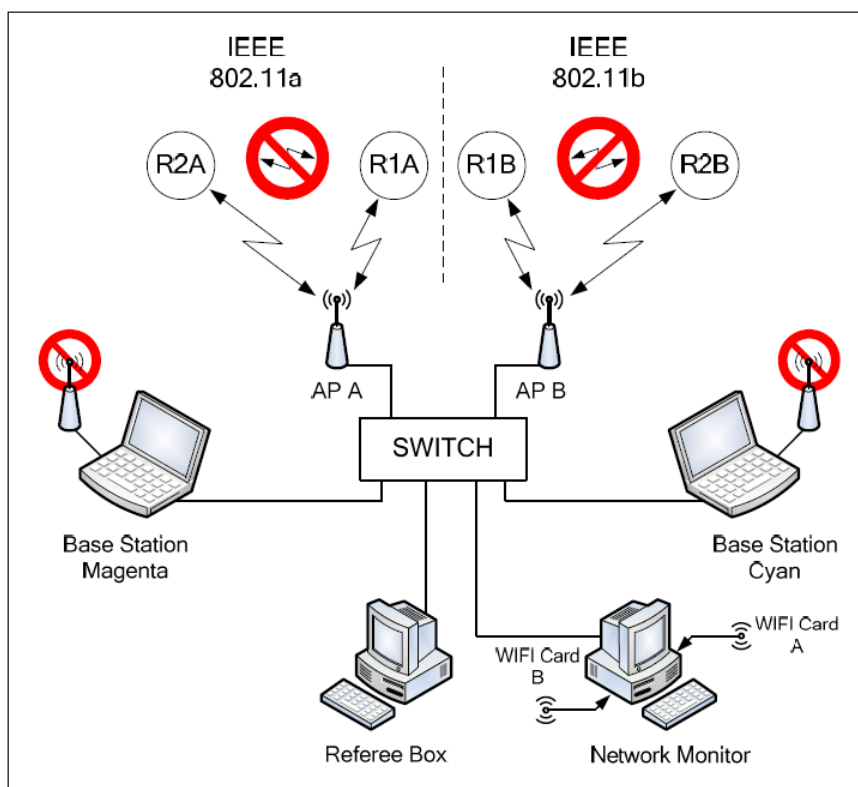

**Network Monitor**

A specific computer for network monitoring will be assigned to each field during the competition. This computer must be equipped with two communication modules compliant with IEEE 802.11a and IEEE 802.11b respectively. These modules will only be used to listen to wireless communications and, therefore, will not interfere with normal communications.

This computer, that will also be connected to the wired network, will be running a specific application dedicated to network monitoring in order to verify that all team’s communications comply with these rules.

	RoboCup Changes and Comments
<b>RC-4.2.5: Communications</b>	<p>This application will provide a set of statistics about the overall communications on a particular field, and will allow, at least, the following:</p> <ul style="list-style-type: none"> <li>• Identification of all authorized and non-authorized sub-networks.</li> <li>• Accounting, by authorized sub-network and within 10 second periods, of both the number of exchanged packets and the total dimension of exchanged data. This information is registered in a log file.</li> <li>• Logging, for all non-authorized sub-networks, of all exchanged packets. This logging will include, for each packet, the specific identification of the IP and MAC address of the originating node, destination IP and time stamp.</li> <li>• Graphical visualization of the traffic from authorized sub-networks, together with a set of visual alerts for abnormal situations</li> </ul> <p><b>Technical verifications and sanctions</b></p> <p>During technical verifications teams must be prepared to demonstrate and explain their communication setup and software to the MSL Technical Committee. This will include network configuration and bandwidth usage. Furthermore, team robots must be placed in the field and respond to basic Referee Box commands. The Network Monitor software will be used to verify that the team communication setup is in accordance to the rules.</p> <p>Teams that fail to comply with the current communications rules will be asked by the Technical Committee to re-adjust their software and setup in order to correct the detected incompatibilities. If the team fails a second technical verification, it may be excluded from playing in the tournament by the league organizing committee.</p> <p>If, during or after a match, the Network Monitor shows a clear violation of the rules either by the playing teams, or by any other MSL teams in the neighborhood, the reported offending team will be awarded a warning by the technical committee. A second warning, issued to the same team during the tournament, may lead to the team exclusion, by decision of the league organizing committee, under recommendation of the technical committee.</p>
<b>RC-4.2.6: Sensing Systems</b>	<p>Any sensing system is allowed as long as the following constraints are met:</p> <ol style="list-style-type: none"> <li>1. All parts of the sensing system (i.e .the actual sensing device and, if applicable, a signal emitting device) must be on the robots.</li> <li>2. There may be no manipulation of the environment, such as placing specific markers as landmarks.</li> </ol>
<b>RC-4.2.7: Ball Handling Mechanisms</b>	<p>Robots may have special devices for ball handling. Ball handling devices must be designed such that they are safe. The robot's use of ball handling devices must comply with the Laws set forth in Fouls and Misconduct.</p>

### FL 4.3 Shin-guards

- are covered entirely by the stockings.
- are made of a suitable material (rubber, plastic, or similar substances).

- provide a reasonable degree of protection.

 <b>RoboCup Changes and Comments</b>	
<b>RC-4.3.1: Robustness</b>	Robot soccer players must be built such that they are <b>robust</b> . Robust means that the physical integrity of the robot is not endangered by incidental, accidental, or intentional collisions with the ball or objects of the field or other robots. The robot’s sensing systems and software should be able to handle potentially significant levels of noise caused by other sources, such as other robots, game officials, team members, spectators, or the media. Robots are allowed to kick a ball upward with no penalty. This means that the robots should be build strong enough to tolerate it.

#### FL 4.4 Goalkeepers

- wear colors which distinguish them from the other players, the referee and the assistant referees

 <b>RoboCup Changes and Comments</b>	
<b>RC-4.4: Goalkeepers</b>	Goalkeepers must obey the same coloring and marker constraints as the other robots in their team. The design of the top marker must indicate that a player is a goal keeper. If a normal player is substituted as a goal keeper, the player must wear the top marker of the substituted goal keeper in order to clarify that the player is goal keeper. The substituted goal keeper does not have to wear the side color and number marker of the regular goal keeper.

#### FL 4.5 Infringements/Sanctions

For any infringement of this Law:

- Play need not be stopped.
- The player at fault is instructed by the referee to leave the field of play to correct his equipment.
- The player leaves the field of play when the ball next ceases to be in play, unless he has already corrected his equipment.
- Any player required to leave the field of play to correct his equipment does not re-enter without the referee’s permission.
- The referee checks that the player’s equipment is correct before allowing him to re-enter the field of play.
- The player is only allowed to re-enter the field of play when the ball is out of play.

A player who has been required to leave the field of play because of an infringement of this Law and who enters (or re-enters) the field of play without the referee’s permission is cautioned and shown the yellow card.

 <b>RoboCup</b>	<b>RoboCup Changes and Comments</b>
<b>RC-4.5.1: Repair of Robots</b>	<p>Team leaders may ask the referee for permission to remove a player from the field, if there is a problem with the player's hardware and/or software.</p> <p>If the referee gives permission to remove a player, one human team member, who must be properly dressed and who has been identified to the referee before the start of the game, may enter the field and remove a robot only during a game stoppage.</p> <p>Robots must be repaired outside of the safety boundary around the field.</p> <p>Checking that the player's equipment is correct may also be done by assistant referees.</p> <p>After a player has been repaired or a player's equipment has been corrected the player is allowed to enter the field only during a game stoppage and after permission of the referee.</p> <p>The referee shall give permission to re-enter the field only if at least 30 seconds have passed since the robot has been removed from the field, and only if no immediate interference with the game process will occur.</p>

## FL 4.6 Restart of Play

If play is stopped by the referee to administer a caution:

- the match is restarted by an indirect free kick taken by a player of the opposing side, from the place where the ball was located when the referee stopped the match.

## FIFA LAW 5 – The Referee

### FL 5.1 The Authority of the Referee

Each match is controlled by a referee who has full authority to enforce the Laws of the Game in connection with the match to which he has been appointed.

### FL 5.2 Powers and Duties

The Referee:

- enforces the Laws of the Game.
- controls the match in co-operation with the assistant referees and, where applicable, with the fourth official.
- ensures that the ball meets the requirements of FIFA LAW 2.
- ensures that the players' equipment meets the requirements of FIFA LAW 4.
- acts as timekeeper and keeps a record of the match.
- stops, suspends or terminates the match, at his discretion, for any infringements of the Laws.
- stops, suspends or terminates the match because of outside interference of any kind.
- stops the match if, in his opinion, a player is seriously injured and ensures that he is removed from the field of play.
- allows play to continue until the ball is out of play if a player is, in his opinion, only slightly injured.
- ensures that any player bleeding from a wound leaves the field of play. The player may only return on receiving a signal from the referee, who must be satisfied that the bleeding has stopped.
- allows play to continue when the team against which an offence has been committed will benefit from such an advantage and penalizes the original offence if the anticipated advantage does not ensue at that time.
- punishes the more serious offence when a player commits more than one offence at the same time.
- takes disciplinary action against players guilty of cautionable and sending-off offences. He is not obliged to take this action immediately but must do so when the ball next goes out of play.
- takes action against team officials who fail to conduct themselves in a responsible manner and may at his discretion, expel them from the field of play and its immediate surrounds.
- acts on the advice of assistant referees regarding incidents which he has not seen.
- ensures that no unauthorized persons enter the field of play.
- restarts the match after it has been stopped.
- provides the appropriate authorities with a match report which includes information on any disciplinary action taken against players, and/or team officials and any other incidents which occurred before, during or after the match.

	<b>RoboCup Changes and Comments</b>
<b>RC-5.3: Powers and Duties</b>	In RoboCup, some referee duties like time keeping and keeping a record of the match may be delegated to one of the assistant referees.

 <b>RoboCup</b>	<b>RoboCup Changes and Comments</b>
<b>RC-5.3.1: Referee Box</b>	In RoboCup, assisting technology is used to support the referee, in particular for conveying referee decisions to robot players and for maintaining a record of the game. Such assisting technology includes a referee box and possibly other sorts of technology. In particular, whenever the Laws of the Game specify that the referee is giving a signal, the referee box protocol specifies the communication of one or more messages to the team remote computer system. Operation of the referee box is delegated to an assistant referee.
<b>RC-5.3.2: Permission to stop the robots</b>	Whenever a robot shows a behavior which is clearly dangerous either to the opponent robots or to spectators, a single human team-member is allowed to enter the field without permission of the referee to stop the robot by means of its mandatory emergency stop button. If a robot is stopped in this way, the game is also stopped by the referee and resumed with a free-kick for the other team. This free-kick will be taken from the position where the robot was stopped.

### FL 5.3 Decisions of the Referee

The decisions of the referee regarding facts connected with play are final. The referee may only change a decision on realizing that it is incorrect or, at his discretion, on the advice of an assistant referee, provided that he has not restarted play.

### Decisions of the International F.A. Board

**Decision 1:** A referee (or where applicable, an assistant referee or fourth official) is not held liable for:

- any kind of injury suffered by a player, official or spectator,
- any damage to property of any kind,
- any other loss suffered by any individual, club, company, association or other body, which is due or which may be due to any decision which he may take under the terms of the Laws of the Game or in respect of the normal procedures required to hold, play and control a match.

This may include:

- a decision that the condition of the field of play or its surrounds or that the weather conditions are such as to allow or not to allow a match to take place,
- a decision to abandon a match for whatever reason,
- a decision as to the condition of the fixtures or equipment used during a match including the goalposts, crossbar, flagposts and the ball,
- a decision to stop or not to stop a match due to spectator interference or any problem in the spectator area,
- a decision to stop or not to stop play to allow an injured player to be removed from the field of play for treatment,
- a decision to request or insist that an injured player be removed from the field of play for treatment,
- a decision to allow or not to allow a player to wear certain apparel or equipment,
- a decision (in so far as this may be his responsibility) to allow or not to allow any persons (including team or stadium officials, security officers, photographers or other media representatives) to be present in the vicinity of the field of play,
- any other decision which he may take in accordance with the Laws of the Game or in conformity with his duties under the terms of FIFA, confederation, national association or league rules or regulations under which the match is played.



**Decision 2:** In tournaments or competitions where a fourth official is appointed, his role and duties must be in accordance with the guidelines approved by the International F.A. Board.

**Decision 3:** Facts connected with play shall include whether a goal is scored or not and the result of the match.

## FIFA LAW 6 – The Assistant Referees

### FL 6.1 Duties

Two assistant referees are appointed whose duties, subject to the decision of the referee, are to indicate

- when the whole of the ball has passed out of the field of play,
- which side is entitled to a corner kick, goal kick or throw-in,
- when a player may be penalized for being in an offside position,
- when a substitution is requested,
- when misconduct or any other incident has occurred out of the view of the referee.

 <b>RoboCup Changes and Comments</b>	
<b>RC-6.1: Duties</b>	In RoboCup, one or more assistants may be appointed for a match. The recommendation is to have three assistant referees. One of the assistant referees should be responsible for time keeping and keeping a game record. The referee may assign assistant referees additional duties aside of those specified in the FIFA Law.

### FL 6.2 Assistance

The assistant referees also assist the referee to control the match in accordance with the Laws of the Game.

In the event of undue interference or improper conduct, the referee will relieve an assistant referee of his duties and make a report to the appropriate authorities.

## FIFA LAW 7 – The Duration of the Match

### FL 7.1 Periods of Play

The match lasts two equal periods of 45 minutes, unless otherwise mutually agreed between the referee and the two participating teams.

Any agreement to alter the periods of play (for example to reduce each half to 40 minutes because of insufficient light) must be made before the start of play and must comply with competition rules.

	RoboCup Changes and Comments
<b>RC-7.1: Periods of Play</b>	In RoboCup, a match lasts two equal periods of 15 minutes (clock-time). For friendly games, referee and both teams may decide on different periods of play. In official tournaments, modifications of periods of play may be specified by the organizing committee.

### FL 7.2 Half-Time Interval

Players are entitled to an interval at half-time. The half-time interval must not exceed 15 minutes. Competition rules must state the duration of the half-time interval. The duration of the half-time interval may be altered only with the consent of the referee.

	RoboCup Changes and Comments
<b>RC-7.2: Half-Time Interval</b>	In RoboCup, the half-time interval must not exceed 5 minutes.

### FL 7.3 Allowance for Time Lost

Allowance is made in either period for all time lost through

- substitution(s),
- assessment of injury to players,
- removal of injured players from the field of play for treatment,
- wasting time,
- any other cause.

The allowance for time lost is at the discretion of the referee.

### FL 7.4 Penalty Kick

If a penalty kick has to be taken or retaken, the duration of either half is extended until the penalty kick is completed.

### FL 7.5 Extra Time

Competition rules may provide for two further equal periods to be played. The conditions of FIFA LAW 8 will apply.

### FL 7.6 Abandoned Match

An abandoned match is replayed unless the competition rules provide otherwise.

## FIFA LAW 8 – The Start and Restart of Play

### FL 8.1 Preliminaries

A coin is tossed and the team which wins the toss decides which goal it will attack in the first half of the match.

The other team takes the kick-off to start the match.

The team which wins the toss takes the kick-off to start the second half of the match.

In the second half of the match the teams change ends and attack the opposite goals.

	RoboCup Changes and Comments
<b>RC-8.1.1: Start Delay</b>	For RoboCup, a match must start at the scheduled time. In exceptional situations only, the referee may re-adjust the time for starting the game in accordance with both team leaders.
<b>RC-8.1.2: Remote Start</b>	All robots of a team are started (and stopped) by receiving a signal through wireless communication from outside the field.

### FL 8.2 Kick-off

A kick-off is a way of starting or restarting play

- at the start of the match,
- after a goal has been scored,
- at the start of the second half of the match,
- at the start of each period of extra time, where applicable.

A goal may be scored directly from the kick-off.

### FL 8.3 Procedure (for kick-off)

- All players are in their own half of the field.
- The opponents of the team taking the kick-off are at least 9.15m (10yds) from the ball until it is in play.
- The ball is stationary on the center mark.
- The referee gives a signal.
- The ball has to be kicked forward into the side of the defending team.
- The ball is in play when it is kicked and moves forward.
- Unless the ball is in play, all players stay in their own half of the field.
- The kicker does not touch the ball a second time until it has touched another player.

After a team scores a goal, the kick-off is taken by the other team.

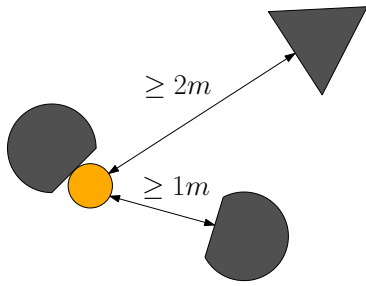
	RoboCup Changes and Comments
<p><b>RC-8.3: Procedure (for Kick-Off)</b></p>	<p>For RoboCup, the following procedure is followed for kick-off:</p> <ul style="list-style-type: none"> <li>• All players are in their own half of the field.</li> <li>• The opponents of the team taking the kick-off are at least 2m from the ball until it is in play.</li> <li>• One robot of the attacking team is positioned at the ball.</li> <li>• The players of the team taking the kick-off other than the kicking robot are at least 1m from the ball until it is in play.</li> <li>• All robots, except the kicking robot, are not allowed to touch the ball until it is in play.</li> <li>• The ball is stationary on the center mark.</li> <li>• The referee gives a signal.</li> <li>• A player of the team who was awarded the kick-off kicks the ball.</li> <li>• The robot taking the kick should either use its kicker or one of its sides to instantaneously kick (i.e., without dribbling or dragging) the ball such that it travels freely over a distance of at least 0.5m.</li> <li>• The ball is in play immediately after being kicked.</li> <li>• After the kick, the attacking team is only allowed to touch the ball a second time after it moved over a distance of at least 0.5m.</li> <li>• A goal may be scored only when the ball was touched by another player of the same team.</li> <li>• When 10 seconds have passed and the ball wasn't kicked by the attacking team, the defending team can approach the ball and score a goal directly, even without any contact between the ball and any other player. However, even after these 10 seconds, the attacking team can only score a valid goal after the ball has been touched by at least two of its players.</li> <li>• If a robot of the attacking team except the kicking robot approaches the ball before it is in play, the kick-off will be awarded to the other team.</li> </ul> <p>The referee must restart the game within 10 seconds after game stops.</p> 

 <b>RoboCup Changes and Comments</b>	
<b>RC-8.3.1: Positioning of Robots</b>	<p>Robots being able to autonomously reposition themselves can take any position on the field that is consistent with the FIFA Law 8.</p> <p>Robots not able to autonomously reposition themselves can be manually positioned by human team members at the game restart points or behind the game restart points. If all robots of the team executing the kick-off cannot autonomously reposition themselves, then one robot may be placed into the center circle.</p>

#### FL 8.4 Infringements/Sanctions (for kick-off)

If the kicker touches the ball a second time before it has touched another player:

- An indirect free kick is awarded to the opposing team to be taken from the place where the infringement occurred.

For any other infringement of the kick-off procedure:

- The kick-off is retaken.

 <b>RoboCup Changes and Comments</b>	
<b>RC-8.4.1: Kicking Directly to the goal</b>	<p>In RoboCup, if the ball is kicked by the team that has kick-off and enters the goal without being touched by a second player of the same team before crossing the goal line, the goal is not scored and the kick-off is awarded to the opposing team. When 10 seconds have passed since the signal and the attacking team didn't touch the ball, a goal may be scored directly by the defending team.</p>

#### FL 8.5 Dropped Ball

A dropped ball is a way of restarting the match after a temporary stoppage which becomes necessary, while the ball is in play, for any reason not mentioned elsewhere in the Laws of the Game.

 <b>RoboCup Changes and Comments</b>	
<b>RC-8.5.1: Game Stuck</b>	<p>In RoboCup, the referee may call a game stuck situation if there is no progress of the game. The game is continued using the dropped ball procedure. The ball is placed at the point it was when the dropped ball was called.</p>

#### FL 8.6 Procedure (for dropped ball)

The referee drops the ball at the place where it was located when play was stopped. Play restarts when the ball touches the ground.

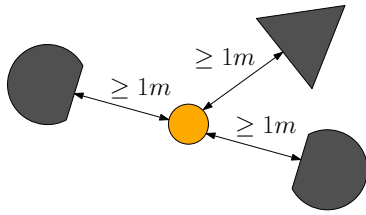
 <b>RoboCup Changes and Comments</b>	
<p><b>RC-8.6: Procedure (for Dropped Ball)</b></p>	<p>In RoboCup, the following procedure is followed for dropped ball:</p> <ul style="list-style-type: none"> <li>• The referee gives a “stop” signal.</li> <li>• All players have to stop their movement.</li> <li>• The ball is stationary positioned in the place where it was located when the game was stopped.</li> <li>• The referee gives a “dropped ball” signal.</li> <li>• All players remain 1m away from the ball. One robot may stay anywhere inside the penalty area (except goal area) of its own team, even if the distance to the ball is shorter than 1m.</li> <li>• The referee gives a “start” signal.</li> <li>• The ball is in play immediately after the referee gives the signal.</li> <li>• In RoboCup a goal may not be scored directly from a dropped ball. To score a goal, the ball has to be touched by at least two robots (not necessarily of the same team).</li> <li>• See also RC-12.3.8 - Delay of game.</li> </ul> <p>It is forbidden to reposition robots by hand or by any other means. The referee may show a yellow card to the robot that doesn't stay at at least 1m from the ball, following the referee's instructions more than twice consecutively. After that, if the robot doesn't follow the position restrictions of the procedure, the referee may instruct the team to remove the robot from the field. The referee must restart the game within 10 seconds after game stops.</p> <div style="text-align: center;">  </div>

**FL 8.7 Infringements/Sanctions (for dropped ball)**

The ball is dropped again:

- If it is touched by a player before it makes contact with the ground.
- If the ball leaves the field of play after it makes contact with the ground, without a player touching it.

 <b>RoboCup Changes and Comments</b>	
<p><b>RC-8.7: Infringements/ Sanctions</b></p>	<p>If a player moves within 1m from the ball before the referee gives the signal, an indirect free kick is awarded to the opponent.</p>

**FL 8.8 Special Circumstances**

A free kick awarded to the defending team inside its own goal area is taken from any point within the goal area.

An indirect free kick awarded to the attacking team in its opponents' goal area is taken from the goal area line parallel to the goal line at the point nearest to where the infringement occurred.

A dropped ball to restart the match after play has been temporarily stopped inside the goal area takes place on the goal area line parallel to the goal line at the point nearest to where the ball was located when play was stopped.



## FIFA LAW 9 – The Ball In and Out of Play

### FL 9.1 Ball Out of Play

The ball is out of play when:

- It has wholly crossed the goal line or touch line whether on the ground or in the air.
- Play has been stopped by the referee.

 <b>RoboCup</b>	<b>RoboCup Changes and Comments</b>
<b>RC-9.1.1: Dead Call</b>	In RoboCup, a special “ <i>dead call</i> ” signal may be given by the referee, upon which all robots immediately have to cease operating any kind of actuator. The referee may signal a dead call at any time upon his discretion. In particular, the referee may signal a dead call whenever he considers it necessary to maintain and ensure safety and security of players, team members, referees, and spectators.
<b>RC-9.1.2: Continuation after Dead Call</b>	After a dead call, the game continues with a dropped ball at the position nearest to the ball location when the game was interrupted, except when the referee issued a different call prior to the dead call.

### FL 9.2 Ball In Play

The ball is in play at all other times, including when:

- It rebounds from a goalpost, crossbar or corner flagpost and remains in the field of play.
- It rebounds from either the referee or an assistant referee when they are on the field of play.

## **FIFA LAW 10 – The Method of Scoring**

### **FL 10.1 Goal Scored**

A goal is scored when the whole of the ball passes over the goal line, between the goalposts and under the crossbar, provided that no infringement of the Laws of the Game has been committed previously by the team scoring the goal.

### **FL 10.2 Winning Team**

The team scoring the greater number of goals during a match is the winner. If both teams score an equal number of goals, or if no goals are scored, the match is drawn.

### **FL 10.3 Competition Rules**

For matches ending in a draw, Competition Rules may state provisions involving extra time, or other procedures approved by the International F.A. Board to determine the winner of a match.

## FIFA LAW 11 – Offside

 <b>RoboCup</b>	<b>RoboCup Changes and Comments</b>
<b>RC-11: Offside</b>	This law does currently not apply in RoboCup matches.

### FL 11.1 Offside Position

It is not an offence in itself to be in an offside position.

A player is in an offside position if:

- He is nearer to his opponents' goal line than both the ball and the second last opponent.

A player is not in an offside position if:

- he is in his own half of the field of play,
- or he is level with the second last opponent,
- or he is level with the last two opponents.

### FL 11.2 Offence

A player in an offside position is only penalized if, at the moment the ball touches or is played by one of his team, he is, in the opinion of the referee, involved in active play by:

- interfering with play,
- or interfering with an opponent,
- or gaining an advantage by being in that position.

### FL 11.3 No Offence

There is no offside offence if a player receives the ball directly from:

- a goal kick,
- or a throw-in,
- or a corner kick.

### FL 11.4 Infringements/Sanctions

For any offside offence, the referee awards an indirect free kick to the opposing team to be taken from the place where the infringement occurred.

## FIFA LAW 12 – Fouls and Misconduct

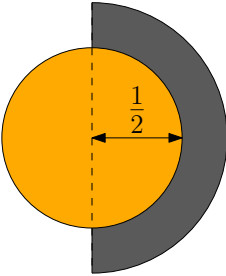
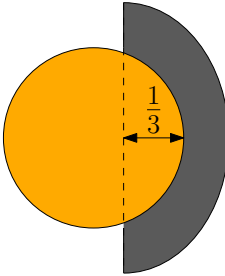
 <b>RoboCup Changes and Comments</b>	
<b>Definition of Permissible Actions for Robot Soccer Players</b>	
<b>RC-12.0: Ball Manipulation</b>	<ul style="list-style-type: none"> <li>• During a game the ball must not enter the convex hull of a robot by more than a third of its diameter except when the robot is stopping the ball. The ball must not enter the convex hull of a robot by more than half of its diameter if the robot is stopping the ball. This case only applies to instantaneous contact between robot and ball lasting no longer than one second. In any case it must be possible for another robot to take possession of the ball.</li> <li>• The robot may exert a force onto the ball only by direct physical contact between robot and ball. Forces exerted onto the ball that hinder the ball from rotating in its natural direction of rotation are allowed for no more than one seconds and a maximal distance of movement of one meter. Exerting this kind of forces repeatedly is allowed only after a waiting time of at least four seconds. Natural direction of rotation means that the ball is rotating in the direction of its movement.</li> <li>• Violating any of the above rules is considered ball holding.</li> </ul> <div style="display: flex; justify-content: space-around; align-items: center;"> <div style="text-align: center;"> <p>Ball stopping</p>  </div> <div style="text-align: center;"> <p>Otherwise</p>  </div> </div>

Fouls and misconduct are penalized as follows:

### FL 12.1 Direct Free Kick

A direct free kick is awarded to the opposing team if a player commits any of the following six offences in a manner considered by the referee to be careless, reckless or using excessive force:

- kicks or attempts to kick an opponent
- trips or attempts to trip an opponent
- jumps at an opponent
- charges an opponent
- strikes or attempts to strike an opponent
- pushes an opponent

A direct free kick is also awarded to the opposing team if a player commits any of the following four offences:

- tackles an opponent to gain possession of the ball, making contact with the opponent before touching the ball
- holds an opponent
- spits at an opponent
- handles the ball deliberately (except for the goalkeeper within his own penalty area)

A direct free kick is taken from where the offence occurred.

	<b>RoboCup Changes and Comments</b>
<b>RC-12.1: Direct Free Kick</b>	Direct free kicks are currently awarded as indirect free kicks.

### FL 12.2 Penalty Kick

A penalty kick is awarded if any of the above ten offences is committed by a player inside his own penalty area, irrespective of the position of the ball, provided it is in play.

	<b>RoboCup Changes and Comments</b>
<b>RC-12.2: Penalty Kick</b>	In RoboCup, penalty kicks are currently not awarded during the two periods of play in a match. The competition rules may specify the execution of penalty kicks to decide the winner of a game which ends in a draw after two periods of play.

### FL 12.3 Indirect Free Kick

An indirect free kick is awarded to the opposing team if a goalkeeper, inside his own penalty area, commits any of the following five offences:

- takes more than four steps while controlling the ball with his hands, before releasing it from his possession
- touches the ball again with his hands after it has been released from his possession and has not

touched any other player

- touches the ball with his hands after it has been deliberately kicked to him by a team-mate
- touches the ball with his hands after he has received it directly from a throw-in taken by a team-mate
- wastes time

An indirect free kick is also awarded to the opposing team if a player, in the opinion of the referee:

- plays in a dangerous manner
- impedes the progress of an opponent
- prevents the goalkeeper from releasing the ball from his hands
- commits any other offence, not previously mentioned in Law 12, for which play is stopped to caution or dismiss a player

The indirect free kick is taken from where the offence occurred.

	<b>RoboCup Changes and Comments</b>
<p><b>RC-12.3: Indirect Free Kick</b></p>	<p>An indirect free kick is awarded to the opposing team, if a player, in the opinion of the referee, commits any of the following offences:</p> <ul style="list-style-type: none"> <li>• holding the ball</li> <li>• pushing an opponent</li> <li>• manual interference (see below)</li> <li>• kicking an opponent</li> <li>• performing illegal defense</li> <li>• performing illegal attack</li> <li>• delay of game</li> </ul> <p><b>Manual interference:</b> An indirect free kick is awarded to the opposing team, if a human member of a team, in the opinion of the referee, commits any of the following offences:</p> <ul style="list-style-type: none"> <li>• entering the field during the game and breaks without permission of the referee</li> <li>• touching the robot during the game and breaks</li> <li>• interfering with the game on the field, e.g. through touching the ball while removing a robot</li> <li>• interfering with the game remotely through wireless communication, e.g. by remotely joysticking a robot, or send commands to robots from a machine not on the robots that convey information about the position of objects on the field or activate particular patterns of actions on the robots</li> <li>• behaving otherwise in an unsportsmanlike manner</li> </ul> <p>The referee may stop the game and give a yellow card to the player that has committed one of those offences. The indirect free kick will be started from where the ball was when the offences occurred if the ball was not inside a penalty area, and from the closest restart point if the ball was inside of a penalty area. The offences are described and clarified subsequently.</p>
<p><b>RC-12.3.1: Ball Holding</b></p>	<p>If a player commits any violation of the clauses on stopping, dribbling, or kicking the ball, a <b>ball holding foul</b> will be called. Ball holding or hindering the ball from rolling in its natural direction is only allowed for at most one second and at most one meter of movement. This kind of action can only be repeated after a waiting time of, at least, four seconds.</p>

	RoboCup Changes and Comments
<b>RC-12.3.2: Pushing</b>	<ul style="list-style-type: none"> <li>• Robots must play such that they try to avoid physical contact. However, physical contact <i>per se</i> does not represent an offence.</li> <li>• All robots must be equipped to detect situations of physical contact with other robots (direct pushing situations). The obligation to detect pushing situations includes also indirect contact with another robot through the ball (i.e. the ball is between the player and an opponent).</li> <li>• If physical contact with other robots cannot be avoided, it must be <b>soft</b>, i.e. at slow speed and with as small physical impact as possible, in order to avoid damage to itself and other robots. Robots moving at high speed must significantly decelerate before a collision with another robot.</li> <li>• Whenever a robot produces direct or indirect physical contact with another robot while moving, it must stop movement immediately in that direction and choose a new direction for movement.</li> <li>• If pushing occurs between a moving and a standing robot, the moving robot causes the pushing situation and is responsible for resolving it.</li> <li>• If pushing occurs between two moving robots, both robots are responsible for resolving the pushing situation. If one robot continues pushing by moving in its initial direction, while the other robot is recognizably reacting and trying to take another direction, the foul will be called on the pushing robot.</li> <li>• If an indirect pushing situation occurs between two robots, and neither of the robots can come out of it or shows significant attempts to get out of it within 10 seconds, a dropped ball will be called.</li> <li>• If two robots encounter physical contact and cannot resolve the situation because they get entangled, the referee may order robot attendants to enter the field and slightly separate the entangled robots.</li> <li>• If, in the opinion of the referee, physical contact between two robots is not soft, or if one or both of the robots do not change direction after encountering physical contact, a <b>pushing foul</b> will be called.</li> </ul>
<b>RC-12.3.3: Kicking</b>	<p>The pushing clauses above apply in a similar manner to kicking motions:</p> <ul style="list-style-type: none"> <li>• Robots must avoid kicking each other. However, physical contact through an actuated kicking device does not <i>per se</i> represent an offence.</li> <li>• All robots must be equipped to decide whether they can execute a kick without threatening or damaging other robots.</li> <li>• If physical contact with other robots cannot be avoided, it must be <b>soft</b>, i.e. with small force. The stronger a kicking device is designed, the more fine-grained control of its activation is required.</li> <li>• If, in the opinion of the referee, physical contact through a kicking device is not soft, a <b>kicking foul</b> will be called.</li> </ul>

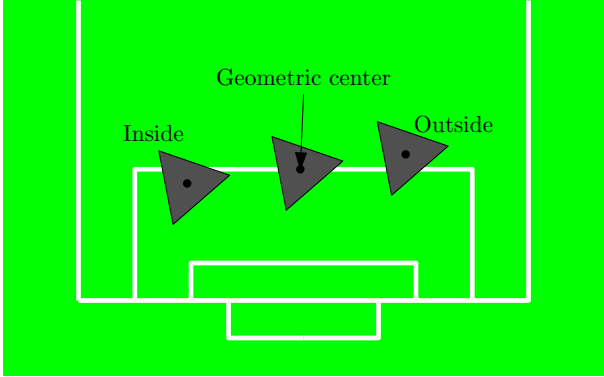

 <span style="margin-left: 20px;"><b>RoboCup Changes and Comments</b></span>	
<p><b>RC-12.3.4: Illegal Defense</b></p>	<ul style="list-style-type: none"> <li>• Only the goal keeper may stay permanently in the own penalty area of a team.</li> <li>• A time limit of 10 seconds is allowed for a defending robot to leave its own penalty area. The referee may extend the time limit at his own discretion if the robot is actively making progress to leave the penalty area, or if it is prevented from leaving the penalty area by other robots.</li> <li>• If, in the opinion of the referee, a defending robot is not taking appropriate action to leave its own penalty area, or if a second defending robot is in the penalty area, an <b>illegal defense foul</b> will be called.</li> <li>• This rule overrides all other rules.</li> <li>• A robot is considered to be inside the penalty area if the projection of the robot’s geometric center on the field overlaps or goes beyond the penalty area line.</li> <li>• The line of the penalty area is a part of the penalty area itself.</li> </ul> <div style="text-align: center; margin-top: 10px;">  </div>
<p><b>RC-12.3.5: Illegal Attack</b></p>	<ul style="list-style-type: none"> <li>• A time limit of 10 seconds is allowed for an attacking robot to (possibly execute a kick motion and) leave the opponent’s penalty area. The referee may extend the time limit at his own discretion, if the robot is actively making progress to leave the opponent’s penalty area, or if it is prevented from leaving the penalty area by other robots.</li> <li>• If, in the opinion of the referee, the attacking robot is not taking appropriate action to leave the opponent’s penalty area, or if a second attacking robot is in the opponent’s penalty area, an <b>illegal attack foul</b> will be called.</li> <li>• This rule overrides all other rules.</li> <li>• The line of the penalty area is a part of the penalty area itself.</li> <li>• Touching the goalie in his goal area is an illegal attack foul; independently of the question whether the goalie moved to the attacker or vice versa.</li> </ul>

 <b>RoboCup</b>	<b>RoboCup Changes and Comments</b>
<b>RC-12.3.6: Manual Interference</b>	<ul style="list-style-type: none"> <li>• Robot attendants must, at all times, avoid any interference with the game process.</li> <li>• If, in the opinion of the referee, a human team member is interfering with the game process on the field, a <b>manual interference foul</b> will be called (e.g. touching the robots during game or breaks without the intention to take them out for repair or when a team member instead of the team leader is entering the field of play during the game or breaks).</li> <li>• A team member asking the spectators to move or hide because they wear clothes with colors used in RoboCup, interferes also with the game process. A referee can treat this also as a <b>manual interference foul</b>.</li> </ul>
<b>RC-12.3.7: Remote Interference</b>	<ul style="list-style-type: none"> <li>• No remote human interference of any kind with the game process is allowed.</li> <li>• In particular, the laptops used for coaching the robots (base station) must remain closed for the full duration of the game.</li> <li>• If, in the opinion of the referee, a human team member is remotely interfering with the game process, a <b>remote interference foul</b> will be called.</li> </ul>
<b>RC-12.3.8: Delay Of Game</b>	<ul style="list-style-type: none"> <li>• If a player removes (for the second time) the ball from its position during a game-stoppage, a <b>delay of game foul</b> can be called.</li> </ul>
<b>RC-12.3.9: Unsportsmanlike Behavior</b>	<ul style="list-style-type: none"> <li>• Human team members must at all times during the match behave in an appropriate manner.</li> <li>• At least the following behaviors are considered unsportsmanlike: <ul style="list-style-type: none"> <li>– not following instructions of the referee and the assistant referees</li> <li>– yelling at or insulting the referees, or the opponent, or the audience</li> </ul> </li> <li>• If, in the opinion of the referee, a human team member is behaving in an inappropriate manner, an <b>unsportsmanlike behavior foul</b> will be called.</li> </ul>

 <b>RoboCup Changes and Comments</b>	
<b>RC-12.3.10: Goalie Protection</b>	<ul style="list-style-type: none"> <li>• Only the goalie is allowed to be in the goal area.</li> <li>• If an attacking robot enters the defender’s goal area (i.e. when the projection of the robot’s geometric center on the field overlaps or goes beyond the goal area line), then it will cause a foul.</li> <li>• If a defending robot other than the goalie enters the defender’s goal area (i.e. when the projection of the robot’s geometric center on the field overlaps or goes beyond the goal area line), then it will cause a foul.</li> <li>• The line of the goal area is a part of the goal area itself.</li> </ul>
<b>RC-12.3.11: Manual Positioning</b>	<ul style="list-style-type: none"> <li>• It is not allowed to re-position robots manually during a game break. If a robot needs to be re-positioned, it has to be taken out for repair. The only exception of this rule is the manual kick-off when a team’s robots cannot position themselves.</li> </ul>

## FL 12.4 Disciplinary Sanctions

Only a player or substitute or substituted player may be shown the red or yellow card.

## FL 12.5 Cautionable Offences

A player is cautioned and shown the yellow card if he commits any of the following seven offences:

- is guilty of unsporting behavior
- shows dissent by word or action
- persistently infringes the Laws of the Game
- delays the restart of play
- fails to respect the required distance when play is restarted with a corner kick or free kick
- enters or re-enters the field of play without the referee’s permission
- deliberately leaves the field of play without the referee’s permission

 <b>RoboCup Changes and Comments</b>	
<b>RC-12.5: Cautionable Offences</b>	In RoboCup, a robot player or human team member is cautioned and shown the yellow card if he commits any of the following offences: <ul style="list-style-type: none"> <li>• is guilty of unsporting behavior</li> <li>• persistently infringes the Laws of the Game</li> <li>• delays the restart of play</li> <li>• fails to respect the required distance when play is restarted with a corner kick, goal kick, throw in or free kick</li> <li>• enters the field of play without the referee's permission. Exceptions are defined in RC-4.1 and RC-5.3.2</li> </ul>
<b>RC-12.5.1: Yellow Cards</b>	The assistant referees will maintain a count of yellow cards given to each player (e.g. by the refbox).

### FL 12.6 Sending-Off Offences

A player is sent off and shown the red card if he commits any of the following seven offences:

- is guilty of serious foul play
- is guilty of violent conduct
- spits at an opponent or any other person
- denies the opposing team a goal or an obvious goal-scoring opportunity by deliberately handling the ball (this does not apply to a goalkeeper within his own penalty area)
- denies an obvious goal-scoring opportunity to an opponent moving towards the player's goal by an offence punishable by a free kick or a penalty kick
- uses offensive, insulting or abusive language
- receives a second caution in the same match

 <b>RoboCup Changes and Comments</b>	
<b>RC-12.6: Temporary Sent-Off</b>	A player is temporarily sent off the field after receiving its second yellow card. The player may return to the game on the next game interrupt, but no less than 2 minutes after being temporarily sent off.

 <b>RoboCup Changes and Comments</b>	
<b>RC-12.6: Sending-Off Offences</b>	<p>A robot player or human team member is shown the red card and sent off for the remainder of the game if it commits any of the following offences:</p> <ul style="list-style-type: none"> <li>• is guilty of serious foul play, especially when exhibiting behavior considered to be reckless and rude, or presenting a threat to other robots, human team members, the referees, and the audience</li> <li>• spits at an opponent or any other person</li> <li>• denies the opposing team a goal or an obvious goal-scoring opportunity by deliberately handling the ball (this applies only to human team members)</li> <li>• is guilty of violent conduct</li> <li>• uses offensive, insulting or abusive language</li> <li>• receives the third yellow card in the same match</li> </ul>

### Decisions of the International F.A. Board

**Decision 1:** A penalty kick is awarded if, while the ball is in play, the goalkeeper, inside his own penalty area, strikes or attempts to strike an opponent by throwing the ball at him.

**Decision 2:** A player who commits a cautionable or sending-off offence, either on or off the field of play, whether directed towards an opponent, a team-mate, the referee, an assistant referee or any other person, is disciplined according to the nature of the offence committed.

**Decision 3:** The goalkeeper is considered to be in control of the ball by touching it with any part of his hand or arms. Possession of the ball includes the goalkeeper deliberately parrying the ball, but does not include the circumstances where, in the opinion of the referee, the ball rebounds accidentally from the goalkeeper, for example after he has made a save. The goalkeeper is considered to be guilty of time-wasting if he holds the ball in his hands or arms for more than 5-6 seconds.

**Decision 4:** Subject to the terms of Law 12, a player may pass the ball to his own goalkeeper using his head or chest or knee, etc. If, however, in the opinion of the referee, a player uses a deliberate trick while the ball is in play in order to circumvent the Law, the player is guilty of unsporting behavior. He is cautioned, shown the yellow card and an indirect free kick is awarded to the opposing team from the place where the infringement occurred.

A player using a deliberate trick to circumvent the Law while he is taking a free kick, is cautioned for unsporting behavior and shown the yellow card. The free kick is retaken.

In such circumstances, it is irrelevant whether the goalkeeper subsequently touches the ball with his hands or not. The offence is committed by the player in attempting to circumvent both the letter and the spirit of Law 12.

**Decision 5:** A tackle from behind, which endangers the safety of an opponent, must be sanctioned as serious foul play.

 <b>RoboCup Changes and Comments</b>	
<b>RC-Decision 1-4:</b>	The Intl. F.A. Board Decisions 1 to 4 do currently not apply to RoboCup.

## FIFA LAW 13 – Free Kicks

### FL 13.1 Types of Free Kicks

Free kicks are either direct or indirect.

For both direct and indirect free kicks, the ball must be stationary when the kick is taken and the kicker does not touch the ball a second time until it has touched another player.

	RoboCup Changes and Comments
<b>RC-13.1.1: Free kicks</b>	In RoboCup, an indirect free kick is awarded in all situations where the Laws of the Game specify a direct free kick.
<b>RC-13.1.2: Touching</b>	In RoboCup, the kicker may touch the ball arbitrarily many times as long as the ball has not moved over a distance of more than 0.20m after an indirect free kick. After that, the ball must be touched by another player before the kicking robot can touch the ball again. A goal may be scored only after the ball has been touched by another player of the same team.

### FL 13.2 The Direct Free Kick

- If a direct free kick is kicked directly into the opponents' goal, a goal is awarded.
- If a direct free kick is kicked directly into the team's own goal, a corner kick is awarded to the opposing team.

### FL 13.3 The Indirect Free Kick

**Signal** The referee indicates an indirect free kick by raising his arm above his head. He maintains his arm in that position until the kick has been taken and the ball has touched another player or goes out of play.

**Ball Enters the Goal** A goal can be scored only if the ball subsequently touches another player before it enters the goal.

- If an indirect free kick is kicked directly into the opponents' goal, a goal kick is awarded.
- If an indirect free kick is kicked directly into the team's own goal, a corner kick is awarded to the opposing team.

### FL 13.4 Position of Free Kick

#### Free Kick Inside the Penalty Area

Direct or indirect free kick to the defending team:

- all opponents are at least 9.15m (10yds) from the ball.
- all opponents remain outside the penalty area until the ball is in play.
- the ball is in play when it is kicked directly beyond the penalty area.
- a free kick awarded in the goal area is taken from any point inside that area.

Indirect free kick to the attacking team:

- All opponents are at least 9.15m (10yds) from the ball until it is in play, unless they are on their own goal line between the goalposts.
- the ball is in play when it is kicked and moves
- an indirect free kick awarded inside the goal area is taken from that part of the goal area line which runs parallel to the goal line, at the point nearest to where the infringement occurred.

**Free Kick Outside the Penalty Area**

- All opponents are at least 9.15m (10yds) from the ball until it is in play.
- The ball is in play when it is kicked and moves.
- The free kick is taken from the place where the infringement occurred.

 <b>RoboCup Changes and Comments</b>	
<b>RC-13.4: Position of the Free Kick</b>	For RoboCup, replace “ <i>9.15m</i> ” with “ <b>2m or anywhere (except goal area) within their own penalty area</b> ”. This means that one robot may be placed anywhere inside the own penalty area (except goal area), even if the distance to the ball is shorter than 2m.

	RoboCup Changes and Comments
<b>RC-13.4.1: Procedure</b>	<p>In RoboCup, the following procedure is used for free-kick:</p> <ul style="list-style-type: none"> <li>• The referee gives a “stop” signal.</li> <li>• All players have to stop their movement.</li> <li>• The indirect free kick will be started from where the ball was when the offences occurred, if the ball was not inside a penalty area and from the closest restart point if the ball was inside of a penalty area.</li> <li>• The referee gives a “free-kick” signal.</li> <li>• One robot of the free-kick awarded team is positioned at the ball.</li> <li>• All other players of the free-kick awarded team can stay anywhere on the field except in a circle with a radius of 1m around the ball until it is in play.</li> <li>• All players of the defending team can stay anywhere on the field except in a circle with a radius of 2m around the ball until it is in play. One robot may stay anywhere inside the penalty area (except goal area) of its own team, even if the distance to the ball is shorter than 2m.</li> <li>• The referee gives a “start” signal.</li> <li>• A player of the team who was awarded the free-kick kicks the ball.</li> <li>• The robot taking the kick should either use its kicker or one of its sides to instantaneously kick (i.e., without dribbling or dragging) the ball such that it travels freely over a distance of at least 0.5m.</li> <li>• The ball is in play immediately after being kicked.</li> <li>• After the kick, the attacking team is only allowed to touch the ball a second time after it moved over a distance of at least 0.5m.</li> <li>• A goal may be scored only when the ball was touched by another player of the same team.</li> <li>• When 10 seconds have passed after the signal and the ball wasn’t kicked by the attacking team, the defending team can approach the ball and score a goal directly, even without any contact between the ball and any other player. However, even after these 10 seconds, the attacking team can only score a valid goal after the ball has been touched by at least two of its players.</li> <li>• If a robot of the attacking team except the kicking robot approaches the ball before it is in play, the free-kick will be awarded to the other team.</li> </ul> <p>It is forbidden to reposition robots by hand or by any other means. The referee may show a yellow card to the robot that doesn’t stay at at least 1m from the ball, following the referee’s instructions more than twice consecutively. After that, if the robot doesn’t follow the position restrictions of the procedure, the referee may instruct the team to remove the robot from the field.</p> <p>The referee must restart the game within 10 seconds after game stops.</p>

### FL 13.5 Infringements/Sanctions

If, when a free kick is taken, an opponent is closer to the ball than the required distance:



- the kick is retaken.

If, when a free kick is taken by the defending team from inside its own penalty area, the ball is not kicked directly into play:

- the kick is retaken.

**Free kick taken by a player other than the goalkeeper**

If, after the ball is in play, the kicker touches the ball a second time (except with his hands) before it has touched another player:

- an indirect free kick is awarded to the opposing team, the kick to be taken from the place where the infringement occurred .

If, after the ball is in play, the kicker deliberately handles the ball before it has touched another player:

- a direct free kick is awarded to the opposing team, the kick to be taken from the place where the infringement occurred.
- a penalty kick is awarded if the infringement occurred inside the kicker’s penalty area.

**Free kick taken by the goalkeeper**

If, after the ball is in play, the goalkeeper touches the ball a second time (except with his hands), before it has touched another player:

- an indirect free kick is awarded to the opposing team, the kick to be taken from the place where the infringement occurred.

If, after the ball is in play, the goalkeeper deliberately handles the ball before it has touched another player:

- a direct free kick is awarded to the opposing team if the infringement occurred outside the goalkeeper’s penalty area, the kick to be taken from the place where the infringement occurred.
- an indirect free kick is awarded to the opposing team if the infringement occurred inside the goalkeeper’s penalty area, the kick to be taken from the place where the infringement occurred.

	<b>RoboCup Changes and Comments</b>
<b>RC-13.5: Infringements/ Sanctions</b>	In RoboCup, all clauses referring to situations, where the player taking the free kick is touching the ball a second time, do currently not apply, except for the limitations defined in RC-13.1.2.

## FIFA LAW 14 – The Penalty Kick

A penalty kick is awarded against a team which commits one of the ten offences for which a direct free kick is awarded, inside its own penalty area and while the ball is in play.

A goal may be scored directly from a penalty kick.

Additional time is allowed for a penalty kick to be taken at the end of each half or at the end of periods of extra time.

### FL 14.1 Position of the Ball and the Players

The ball:

- is placed on the penalty mark.

The player taking the penalty kick:

- is properly identified.

The defending goalkeeper:

- remains on his goal line, facing the kicker, between the goalposts until the ball has been kicked.

The players other than the kicker are located:

- inside the field of play.
- outside the penalty area.
- behind the penalty mark.
- at least 9.15m (10yds) from the penalty mark.

	RoboCup Changes and Comments
<b>RC-14.1: Position of Ball and Players</b>	In RoboCup, the following modification apply: <ul style="list-style-type: none"> <li>• The defending goal keeper stays within his own goal area until the ball is even slightly moved.</li> <li>• The goalie stands still on one point.</li> <li>• The kicker is located inside the center circle.</li> <li>• The players other than the kicker are located inside the field of play, outside the center circle, and behind the center line on the opposite side of the defending goal keeper.</li> </ul>

### FL 14.2 The Referee

- does not signal for a penalty kick to be taken until the players have taken up position in accordance with the Law.
- decides when a penalty kick has been completed.

	RoboCup Changes and Comments
<b>RC-14.2: The Referee</b>	The Procedure specifies additional criteria for deciding when a penalty kick has been completed.

**FL 14.3 Procedure**

- The player taking the penalty kicks the ball forward.
- He does not play the ball a second time until it has touched another player.
- The ball is in play when it is kicked and moves forward.

When a penalty kick is taken during the normal course of play, or time has been extended at half-time or full time to allow a penalty kick to be taken or retaken, a goal is awarded if, before passing between the goalposts and under the crossbar:

- the ball touches either or both of the goalposts and/or the crossbar, and/or the goalkeeper.

 <b>RoboCup Changes and Comments</b>	
<p><b>RC-14.3: Procedure</b></p>	<p>In RoboCup, the following procedure is followed for a penalty kick:</p> <ul style="list-style-type: none"> <li>• The penalty starts 5 min. after the end of the 2nd half.</li> <li>• Each team is awarded five penalty shots.</li> <li>• All players take their positions. The ball is placed on the penalty mark by the referee or one of the assistant referees.</li> <li>• The referee gives a signal.</li> <li>• The ball is in play when it was even slightly moved.</li> <li>• After the field robot catches the ball, the ball may only move in a direction towards the goal.</li> <li>• The robot must kick the ball before the ball enters the penalty area, otherwise no goal is awarded.</li> <li>• When the ball is in play, the goalie is allowed to move within the goal area only.</li> <li>• A goal is awarded if the ball passes the goal line between the goal posts and under the crossbar within 30 seconds after the signal of the referee.</li> <li>• No field player can touch the ball again and exert force on it after it has been touched by the goal keeper.</li> <li>• If the goalie leaves the goal area this shot will be repeated. If the same happens again the goal will be awarded.</li> <li>• It is only allowed to kick the ball once.</li> <li>• If the kicker touches the ball a second time, a possible goal will not be awarded.</li> <li>• All 5 penalties of one team are taken sequentially, followed directly by the 5 penalties of the other team.</li> <li>• If after the series, there is a tie, both teams are awarded one more penalty until one team misses. If after 5 more penalties of each team there is still no winner, the game will be decided by a toss.</li> </ul>

## **FL 14.4 Infringements/Sanctions**

**If the referee gives the signal for a penalty kick to be taken and, before the ball is in play, one of the following situations occurs:**

**The player taking the penalty kick infringes the Laws of the Game:**

- The referee allows the kick to proceed.
- If the ball enters the goal, the kick is retaken.
- If the ball does not enter the goal, the kick is not retaken.

**The goalkeeper infringes the Laws of the Game:**

- The referee allows the kick to proceed.
- If the ball enters the goal, a goal is awarded.
- If the ball does not enter the goal, the kick is retaken.

**A team-mate of the player taking the kick enters the penalty area or moves in front of or within 9.15 m (10 yds) of the penalty mark:**

- The referee allows the kick to proceed.
- If the ball enters the goal, the kick is retaken.
- If the ball does not enter the goal, the kick is not retaken.
- If the ball rebounds from the goalkeeper, the crossbar or the goal post and is touched by this player, the referee stops play and restarts the match with an indirect free kick to the defending team.

**A team-mate of the goalkeeper enters the penalty area or moves in front of or within 9.15 m (10 yds) of the penalty mark:**

- The referee allows the kick to proceed.
- If the ball enters the goal, a goal is awarded.
- If the ball does not enter the goal, the kick is retaken.

**A player of both the defending team and the attacking team infringe the Laws of the Game:**

- The kick is retaken.

**If, after the penalty kick has been taken:**

**The kicker touches the ball a second time (except with his hands) before it has touched another player:**

- An indirect free kick is awarded to the opposing team, the kick to be taken from the place where the infringement occurred.

**The kicker deliberately handles the ball before it has touched another player:**

- A direct free kick is awarded to the opposing team, the kick to be taken from the place where the infringement occurred.

**The ball is touched by an outside agent as it moves forward:**

- the kick is retaken.

The ball rebounds into the field of play from the goalkeeper, the crossbar or the goalposts, and is then touched by an outside agent:

- The referee stops play.
- Play is restarted with a dropped ball at the place where it touched the outside agent.

 RoboCup	RoboCup Changes and Comments
RC-14.4: Infringements/ Sanctions	For RoboCup, replace “ <i>enters the penalty area or moves in front of or within 9.15m (10yds) of the penalty mark</i> ” with “ <b>enters the side of the field where the penalty kick takes place</b> ”.

## **FIFA LAW 15 – The Throw-In**

A throw-in is a method of restarting play.

A goal cannot be scored directly from a throw-in.

A throw-in is awarded

- when the whole of the ball passes over the touch line, either on the ground or in the air,
- from the point where it crossed the touch line,
- to the opponents of the player who last touched the ball.

### **FL 15.1 Procedure (The Throw-In)**

At the moment of delivering the ball, the thrower

- faces the field of play,
- has part of each foot either on the touch line or on the ground outside the touch line,
- uses both hands,
- delivers the ball from behind and over his head.

The thrower may not touch the ball again until it has touched another player.

The ball is in play immediately after it enters the field of play.

	RoboCup Changes and Comments
<b>RC-15.1: Procedure</b>	<p>In RoboCup, the following procedure is used for throw-in:</p> <ul style="list-style-type: none"> <li>• The referee gives a “stop” signal.</li> <li>• All players have to stop their movement.</li> <li>• The ball is placed on the touch line by the referee or one of the assistant referees.</li> <li>• The referee gives a “throw-in” signal.</li> <li>• One robot of the throw-in awarded team is positioned at the ball.</li> <li>• All other players of the throw-in awarded team can stay anywhere on the field except in a circle with a radius of 1m around the ball until it is in play.</li> <li>• All players of the defending team can stay anywhere on the field except in a circle with a radius of 2m around the ball until it is in play. One robot may stay anywhere inside the penalty area (except goal area) of its own team, even if the distance to the ball is shorter than 2m.</li> <li>• The referee gives a “start” signal.</li> <li>• A player of the team who was awarded the throw-in kicks the ball.</li> <li>• The robot taking the kick should either use its kicker or one of its sides to instantaneously kick (i.e., without dribbling or dragging) the ball such that it travels freely over a distance of at least 0.5m.</li> <li>• The ball is in play immediately after being kicked.</li> <li>• After the kick, the attacking team is only allowed to touch the ball a second time after it moved over a distance of at least 0.5m.</li> <li>• A goal may be scored only when the ball was touched by another player of the same team.</li> <li>• When 10 seconds have passed after the signal and the ball wasn’t kicked by the attacking team, the defending team can approach the ball and score a goal directly, even without any contact between the ball and any other player. However, even after these 10 seconds, the attacking team can only score a valid goal after the ball has been touched by at least two of its players.</li> <li>• If a robot of the attacking team except the kicking robot approaches the ball before it is in play, a free-kick will be awarded to the other team.</li> </ul> <p>It is forbidden to reposition robots by hand or by any other means. The referee may show a yellow card to the robot that doesn’t stay at at least 1m from the ball, following the referee’s instructions more than twice consecutively. After that, if the robot doesn’t follow the position restrictions of the procedure, the referee may instruct the team to remove the robot from the field. The referee must restart the game within 10 seconds after game stops.</p>

## FL 15.2 Infringements/Sanctions

### Throw-in taken by a player other than the goalkeeper

If, after the ball is in play, the thrower touches the ball a second time (except with his hands) before it has touched another player

- an indirect free kick is awarded to the opposing team, the kick to be taken from the place where the infringement occurred.

If, after the ball is in play, the thrower deliberately handles the ball before it has touched another player:

- A direct free kick is awarded to the opposing team, the kick to be taken from the place where the infringement occurred.
- A penalty kick is awarded if the infringement occurred inside the thrower's penalty area.

### Throw-in taken by the goalkeeper

If, after the ball is in play, the goalkeeper touches the ball a second time (except with his hands), before it has touched another player

- an indirect free kick is awarded to the opposing team, the kick to be taken from the place where the infringement occurred.

If, after the ball is in play, the goalkeeper deliberately handles the ball before it has touched another player:

- A direct free kick is awarded to the opposing team if the infringement occurred outside the goalkeeper's penalty area, the kick to be taken from the place where the infringement occurred.
- An indirect free kick is awarded to the opposing team if the infringement occurred inside the goalkeeper's penalty area, the kick to be taken from the place where the infringement occurred.

If an opponent unfairly distracts or impedes the thrower

- he is cautioned for unsporting behavior and shown the yellow card.

For any other infringement of this Law

- the throw-in is taken by a player of the opposing team.

	RoboCup Changes and Comments
<b>RC-15.2: Infringements/ Sanctions</b>	In RoboCup, all clauses referring to situations, where the player taking the throw-in is touching the ball a second time, do currently not apply, except for the limitations defined in RC-13.1.2.



## **FIFA LAW 16 – The Goal Kick**

A goal kick is a method of restarting play.

A goal may be scored directly from a goal kick, but only against the opposing team.

A goal kick is awarded when

- the whole of the ball, having last touched a player of the attacking team, passes over the goal line, either on the ground or in the air, and a goal is not scored in accordance with Law 10

### **FL 16.1 Procedure (for Goal Kick)**

- The ball is kicked from any point within the goal area by a player of the defending team.
- Opponents remain outside the penalty area until the ball is in play.
- The kicker does not play the ball a second time until it has touched another player.
- The ball is in play when it is kicked directly beyond the penalty area.

	RoboCup Changes and Comments
<b>RC-16.1: Procedure</b>	<p>In RoboCup, the following procedure is used for a goal kick:</p> <ul style="list-style-type: none"> <li>• The referee gives a “stop” signal.</li> <li>• All players have to stop their movement.</li> <li>• The ball is placed at the nearest restart marker to the position where the ball passed the goal line by the referee or one of the assistant referees.</li> <li>• The referee gives a “goal kick” signal.</li> <li>• One robot of the goal kick awarded team is positioned at the ball.</li> <li>• All other players of the goal kick awarded team can stay anywhere on the field except in a circle with a radius of 1m around the ball until it is in play.</li> <li>• All players of the opponent team can stay anywhere on the field except in a circle with a radius of 2m around the ball until it is in play.</li> <li>• The referee gives a “start” signal.</li> <li>• A player of the team who was awarded the goal kick kicks the ball.</li> <li>• The robot taking the kick should either use its kicker or one of its sides to instantaneously kick (i.e., without dribbling or dragging) the ball such that it travels freely over a distance of at least 0.5m.</li> <li>• The ball is in play immediately after being kicked.</li> <li>• After the kick, the attacking team is only allowed to touch the ball a second time after it moved over a distance of at least 0.5m.</li> <li>• A goal may be scored only when the ball was touched by another player of the same team.</li> <li>• When 10 seconds have passed after the signal and the ball wasn’t kicked by the attacking team, the defending team can approach the ball and score a goal directly, even without any contact between the ball and any other player. However, even after these 10 seconds, the attacking team can only score a valid goal after the ball has been touched by at least two of its players.</li> <li>• If a robot of the attacking team except the kicking robot approaches the ball before it is in play, a free-kick will be awarded to the other team.</li> </ul> <p>It is forbidden to reposition robots by hand or by any other means. The referee may show a yellow card to the robot that doesn’t stay at at least 1m from the ball, following the referee’s instructions more than twice consecutively. After that, if the robot doesn’t follow the position restrictions of the procedure, the referee may instruct the team to remove the robot from the field.</p> <p>The referee must restart the game within 10 seconds after game stops.</p>

## FL 16.2 Infringements/Sanctions

If the ball is not kicked directly into play beyond the penalty area

- the kick is retaken.

**Goal kick taken by a player other than the goalkeeper**

If, after the ball is in play, the kicker touches the ball a second time (except with his hands) before it has touched another player

- an indirect free kick is awarded to the opposing team, the kick to be taken from the place where the infringement occurred.

If, after the ball is in play, the kicker deliberately handles the ball before it has touched another player:

- A direct free kick is awarded to the opposing team, the kick to be taken from the place where the infringement occurred.
- A penalty kick is awarded if the infringement occurred inside the kicker’s penalty area

**Goal kick taken by the goalkeeper**

If, after the ball is in play, the goalkeeper touches the ball a second time (except with his hands) before it has touched another player

- an indirect free kick is awarded to the opposing team, the kick to be taken from the place where the infringement occurred.

If, after the ball is in play, the goalkeeper deliberately handles the ball before it has touched another player:

- A direct free kick is awarded to the opposing team if the infringement occurred outside the goalkeeper’s penalty area, the kick to be taken from the place where the infringement occurred.
- An indirect free kick is awarded to the opposing team if the infringement occurred inside the goalkeeper’s penalty area, the kick to be taken from the place where the infringement occurred.

For any other infringement of this Law:

- The kick is retaken

 <b>RoboCup Changes and Comments</b>	
<b>RC-16.2: Infringements/ Sanctions</b>	In RoboCup, all clauses referring to situations, where the player taking the goal kick is touching the ball a second time, do currently not apply, except for the limitations defined in RC-13.1.2.

## **FIFA LAW 17 - The Corner Kick**

A corner kick is a method of restarting play.

A goal may be scored directly from a corner kick, but only against the opposing team.

A corner kick is awarded when

- the whole of the ball, having last touched a player of the defending team, passes over the goal line, either on the ground or in the air, and a goal is not scored in accordance with Law 10.

### **FL 17.1 Procedure (for Corner Kick)**

- The ball is placed inside the corner arc at the nearest corner flagpost.
- The corner flagpost is not moved.
- Opponents remain at least 9.15m (10yds) from the ball until it is in play.
- The ball is kicked by a player of the attacking team.
- The ball is in play when it is kicked and moves.
- The kicker does not play the ball a second time until it has touched another player.

	RoboCup Changes and Comments
<b>RC-17.1: Procedure</b>	<p>In RoboCup, the following procedure is used for a corner kick:</p> <ul style="list-style-type: none"> <li>• The referee gives a “stop” signal.</li> <li>• All players have to stop their movement.</li> <li>• The ball is placed inside the corner arc at the nearest corner to the position where the ball passed the goal line by the referee or one of the assistant referees.</li> <li>• The referee gives a “corner kick” signal.</li> <li>• One robot of the corner kick awarded team is positioned at the ball.</li> <li>• All other players of the corner kick awarded team can stay anywhere on the field except in a circle with a radius of 1m around the ball until it is in play.</li> <li>• All players of the opponent team can stay anywhere on the field except in a circle with a radius of 2m around the ball until it is in play. One robot may stay anywhere inside the penalty area (except goal area) of its own team, even if the distance to the ball is shorter than 2m.</li> <li>• The referee gives a “start” signal.</li> <li>• A player of the team who was awarded the corner kick kicks the ball.</li> <li>• The robot taking the kick should either use its kicker or one of its sides to instantaneously kick (i.e., without dribbling or dragging) the ball such that it travels freely over a distance of at least 0.5m.</li> <li>• The ball is in play immediately after being kicked.</li> <li>• After the kick, the attacking team is only allowed to touch the ball a second time after it moved over a distance of at least 0.5m.</li> <li>• A goal may be scored only when the ball was touched by another player of the same team.</li> <li>• When 10 seconds have passed after the signal and the ball wasn’t kicked by the attacking team, the defending team can approach the ball and score a goal directly, even without any contact between the ball and any other player. However, even after these 10 seconds, the attacking team can only score a valid goal after the ball has been touched by at least two of its players.</li> <li>• If a robot of the attacking team except the kicking robot approaches the ball before it is in play, a free-kick will be awarded to the other team.</li> </ul> <p>It is forbidden to reposition robots by hand or by any other means. The referee may show a yellow card to the robot that doesn’t stay at at least 1m from the ball, following the referee’s instructions more than twice consecutively. After that, if the robot doesn’t follow the position restrictions of the procedure, the referee may instruct the team to remove the robot from the field.</p> <p>The referee must restart the game within 10 seconds after game stops.</p>

## FL 17.2 Infringements/Sanctions

### Corner kick taken by a player other than the goalkeeper

If, after the ball is in play, the kicker touches the ball a second time (except with his hands) before it has touched another player

- an indirect free kick is awarded to the opposing team, the kick to be taken from the place where the infringement occurred.

If, after the ball is in play, the kicker deliberately handles the ball before it has touched another player:

- A direct free kick is awarded to the opposing team, the kick to be taken from the place where the infringement occurred.
- A penalty kick is awarded if the infringement occurred inside the kicker's penalty area.

### Corner kick taken by the goalkeeper

If, after the ball is in play, the goalkeeper touches the ball a second time (except with his hands) before it has touched another player

- an indirect free kick is awarded to the opposing team, the kick to be taken from the place where the infringement occurred.

If, after the ball is in play, the goalkeeper deliberately handles the ball before it has touched another player:

- A direct free kick is awarded to the opposing team if the infringement occurred outside the goalkeeper's penalty area, the kick to be taken from the place where the infringement occurred.
- An indirect free kick is awarded to the opposing team if the infringement occurred inside the goalkeeper's penalty area, the kick to be taken from the place where the infringement occurred.

For any other infringement:

- The kick is retaken

	RoboCup Changes and Comments
<b>RC-17.2: Infringements/ Sanctions</b>	In RoboCup, all clauses referring to situations, where the player taking the corner kick is touching the ball a second time, do currently not apply, except for the limitations defined in RC-13.1.2.

# Chapter

# Competition Rules

Competition Rules include:

- Competition Rule 1 - Team Qualification
- Competition Rule 2 - Referee Recruitment and Assignment
- Competition Rule 3 - Tournament Regulations
- Competition Rule 4 - Summary of Object Coloring
- Competition Rule 5 - Referee Box

## COMPETITION RULE 1 - Team Qualification

### CR 1.0 Admissibility of Team Qualification Procedures

The organizing committee of a tournament may limit the number of teams, that are allowed to participate in the tournament, for any of the following reasons:

- Scientific reasons, for example, when allowing more teams is likely to hurt scientific exchange and discussion or the overall scientific standard of the tournament.
- Space limitations are imposed by the site of the tournament.
- Time limitations are imposed by the overall tournament schedule.
- Any other kind of organizational constraint limits the number of teams that can be accommodated for.

In order to limit the number of participating teams, the organizing committee of a tournament may request teams to successfully complete a qualification procedure. The team qualification procedure shall be such that scientific progress and exchange is fostered.

### CR 1.1 Team Qualification for RoboCup-2009

For RoboCup-2009, the team qualification procedure requires teams to submit the following material:

- A list of 5 scientific papers published during the last 5 years of the team which are related to RoboCup
- Team Description Paper/Innovations of the team
- A list of results and awards obtained by the team in the last 3 year
- A video showing the capabilities of the team's robots
- A list of contributions of the team to the RoboCup MSL community
- Declaration if the team will be part of a mixed team

The material have to be submitted to the TC by the date defined by the TC. Material which arrived after this date will be not considered for the qualification process.

### CR 1.2 Evaluation of the Qualification Material

The submitted qualification material will be evaluated by the TC and in partially by the team leaders of the teams which like to attend RoboCup-2009. For each part of the submitted qualification material a number of points are awarded. These points are summed up per team. The teams are ranked as result of the collected points starting with the highest score. For the ranking of mixed teams the result of the best evaluated sub-team is used. Teams also may send their qualification material only once as one mixed team.

#### Scientific results

Because RoboCup is primarily a scientific (not an entertainment) event, teams are strongly encouraged to submit technical papers to journals, major conferences and workshops. In particular, if a RoboCup tournament is associated or held in conjunction with a conference or a workshop, teams are strongly encouraged to submit papers to the RoboCup-2009 symposium.

In order to decide if the 5 listed publications of the team are relevant for the MSL or RoboCup in general, the papers are reviewed by the team leaders of the teams which have submitted qualification material. The TC assigns a number of papers (abstracts only) to the team leaders. The team leader has to give a feedback if he considers the papers as relevant for the MSL or RoboCup in general. Every paper has to be rated by at least two other team leaders. The participation of the team leader in the review process is mandatory for a successful qualification of the team and has to be done until a date defined by the TC. Papers have to be written in English in order to be evaluated.

Per accepted paper the following points are awarded:



- 6 points for a publication in an international journal or a book chapter
- 4 points for a publication at an international conference (peer-reviewed)
- 2 points for a publication at a national conference (peer-reviewed)
- 1 point for other publications (e.g., not peer-reviewed or PhD-thesis)

A maximum number of 30 points are awarded.

### **Performance in Past Events**

A maximum of 20 points are awarded to a team for the performance in the last 3 years. If a team proceeds to the last 8 teams in a RoboCup world championship in the last 3 years 20 points are awarded to the team. If a team is ranked among the best 3 in the Technical Challenge in a RoboCup world championship in the last 3 years 15 points are awarded to the team. If a team proceeds to the last 8 teams in a regional RoboCup championship (e.g., German Open, Dutch Open, Japan Open, US Open, Iran Open, China Open) in the last 3 years 10 points are awarded to the team.

### **Team Description Paper/Innovations**

Teams have to describe their most innovative contributions or scientific results in a paper with up to 8 pages in the Springer LNCS style. The content of the paper may comprise all topics related to RoboCup MSL or RoboCup in general (e.g. AI Planning, Vision, reinforcement learning, adaptive neural control, development of specialized hardware like sensors or processors for RoboCup, construction of innovative mechanical bases, self-localization, robot cooperation, team coordination, etc.). The submission of a team description paper/innovations is mandatory for the qualification process. The paper will be reviewed by the members of the TC. Each member can award up to 20 points. Finally, the average over all evaluation will be awarded to the team.

### **Qualification Video**

Teams have to submit a 60 seconds long qualification video. The video should show that the robots of the team are able to perform at least the basic actions necessary for the RoboCup MSL. The requested actions are: dribbling the ball, avoiding obstacles, kick towards the goal and a defending action of the goal keeper. For each of these actions which are shown on the video 3 points are awarded. For exceptional abilities (e.g., ball passing) each member of the TC can award up to 8 points. The average over all these evaluation plus the points of the necessary actions will be awarded to the team.

### **Contribution to the RoboCup MSL community**

Contributions or service of the teams to the RoboCup MSL community are very important for the success of our league. Therefore, teams which actively serve for the community has to be honored. Each member of the TC can award up to 10 points for the submitted list of contributions to the community. As contributions or service to the community count serving in league committees (TC, OC), providing code for general use, e.g., the referee box, maintaining the league's homepage. The average over all evaluation will be awarded to the team.

## **CR 1.3 Due Date, Submission, and Review of Team Qualification Material**

All team qualification material must be submitted to the chair of the organizing committee for the middle size robot league by February 1, 2009.

The technical committee will review the material submitted as part of the qualification procedure and select teams for the tournament.

## **CR 1.4 Agreement on Open Source Development**

For the benefit of scientific exchange, teams should make available technology and software developed for RoboCup as much as possible after a tournament has been played.

## COMPETITION RULE 2 - Referees

### CR 2.1 Selection of Referees

Every team participating in a tournament must name at least two team members who serve as referees for matches. The named persons must have good knowledge of the rules as applied in the tournament and have to be able to lead a game in English. The persons should be selected among the more senior members of a team, and preferably have prior experience with games in the RoboCup MSL.

### CR 2.2 Referee Assignment

The assignment of referees and assistants to matches is the task of the league organizing committee. A first selection of possible referees from all participating teams should be done during the registering phase of a tournament. Usually the OC ask all teams to send lists of referee volunteers.

One referee and at least one assistant will be assigned for judgement of a match. The league organizing committee may choose to assign more assistants. The recommended number is one main referee, one assistant referee and two goal assistants.

Assistants can be assigned specific tasks, like handling the stop watch, ensuring the absence of manual interference by team members, and such. It is recommended that the assistant referee takes care of timing, taking notes on cards shown, and filling out the referee game sheet. The duties of the goal assistants is to check the occurrence of goals and survey the timing rules regarding robots in the goal area.

If either a referee or an assistant assigned to a match cannot fulfil his duty for some reason, he has to inform the organizing committee as soon as possible, give the reason for his inability to fulfil his duty, and request a replacement to be named.

### CR 2.3 Referees during Match

The referee and assistant referees should wear black clothing/shoes and avoid reserved colors for the ball, the goals, and player markings in their clothing.

The referee and his assistants will be close to but off the field during play. The referee should take a position at some distance to team areas. The referee may order team members to maintain positions at an appropriate distance.

The referee and the assistants may enter the field in particular situations, e.g. to re-position the ball when the game gets stuck.

The referee and his assistants should avoid to interfere with robots as much as possible, unless a robot is threatening to cause serious damage to people, other robots, or other equipment.

The referee may order team members onto the field in order to move or remove a robot. Orders by the referee have to be executed promptly.

The referee may allow members of a team to enter the field, in particular during game breaks. No team members are allowed to enter the field or to interfere otherwise with the game process unless permitted or ordered by the referee.

### CR 2.4 Infringements/Sanctions

A team failing to meet its refereeing duties, either by not naming appropriate persons to the organizing committee or by the assigned referee not fulfilling his duties, is subject to penalties decided upon by the organizing committee of a tournament.

Penalties may include fines, to be paid immediately before the team's next match, or exclusion from the ongoing or future tournaments.

## COMPETITION RULE 3 - Tournament Regulations

### CR 3.0 Preliminary Remarks

In order to provide a good opportunity to gain match experience, the tournament plan shall be designed such that all teams can play as many games as possible.

### CR 3.1 Parts of the Competition

The RoboCup-2009 competition consist of the following parts:

- Team Registration, Setup, and Technical Inspection
- Technical Evaluation Rounds to assign Scientific and Engineering Awards and define groups for tournament
- Preliminary Rounds (Round-Robin)
- Playoffs

Every team that is admitted to the tournament must participate in all parts of the competition. Teams that do not qualify for the playoffs after the preliminary rounds will have to serve as referees and for various other duties. Teams failing to serve the duties they have been assigned to may be excluded from future tournaments.

### CR 3.2 Team Registration, Setup, and Technical Inspection

Every team has to set up and register on site at least 24 hours before the first game of the tournament is scheduled.

The Middle Size League Committee **strongly recommends** arriving no later than 48 hours before scheduled games start.

It is the sole responsibility of the teams to plan transport of equipment and travel of team members such that both arrive on time. Teams should carefully take into account any potential visa and/or customs problems that may arise.

Teams which did not personally register on site at least 24 hours prior to the first scheduled game may be excluded from the tournament.

Teams excluded from the tournament because of showing up late are not eligible to a refund of registration fees or any other kind of expenses. Neither the RoboCup Federation, nor the local organizers, nor anyone else involved in organizing a RoboCup tournament can be held liable for any cost, or damage suffered, by teams excluded from the tournament.

Team shall set up their robots and equipment and make any adjustments to local conditions well before the first game starts.

During setup, teams should use the field only when necessary, and only for shortest possible times. The League Organizing Committee may impose restrictions on the use of fields during setup and install special procedures for obtaining access to the field.

The Middle Size League Technical Committee will organize a technical inspection of robots during the setup phase. Currently, the following procedure will be followed:

1. Size and shape constraints will not be checked during technical inspection, unless some team leader explicitly requests a check.
2. All robots will be photographed or filmed during technical inspection.
3. Once technical inspection is over, size constraints are checked only if someone assumes some physical change to a robot. Objections may be raised only up to 10 minutes before the game starts and only by a team leader.
4. The opponent team must permit inspection of robots for 10 minutes, from 20 minutes to 10 minutes before game start.
5. No objections will be taken later on.

**Note:** Details of technical inspection are subject to changes by the League Technical Committee at any time, depending on the situation or requests by a team leader meeting on site.

### CR 3.3 Technical Challenge

In order to promote the scientific goals of RoboCup and an according team attitude, the Middle Size League Committee will give recognition to specific scientific and engineering achievements tested by challenge competition, as described in F-2000 Challenges.

Number and character of awards will be determined in accordance with the Executive Committee of the RoboCup Federation.

The results of technical challenges will be taken into consideration to form the groups for the game competition.

Technical challenge tasks will be selected from F-2000 Challenges and announced at an appropriate date.

### CR 3.4 Preliminary Rounds

For the preliminary rounds, teams will be assigned to groups.

The number of groups will be determined by the League Organizing Committee, which takes into account the number of qualified teams as well as site and schedule constraints of the tournament.

Assignment of teams to groups will be done by considering placements in Scientific and Engineering Challenges competition and, as second criterion, by performing a draw. Details of the draw procedure will be announced during a team leader meeting prior to the tournament. Team leaders must be present during the draw procedure.

Each group will play a single round of round-robin matches, i.e. each team will play once against every other team in its group.

As a guideline, every team should be prepared to play as many as eight (8) games within two days.

During the preliminary rounds, a match ending in a draw will NOT be decided by a penalty shoot-out.

The winner of a match will be awarded three (3) points, the loser will be awarded no points. If a match ends in a draw, each team will be awarded one point.

All points awarded to a team are added up.

Teams are ranked within their group by the points they gained during the preliminary round. If two or more teams have the same number of points, a decision is based upon the following criteria, in the order given:

1. Goal difference.
2. Absolute number of goals achieved.
3. Result of direct match-up.
4. Result of technical challenge between tied teams.

The best eight teams of *all* groups qualify for the playoffs.

We assume the number of groups  $m$  to be less than eight. Then the first  $8/m$  (rounded down to the next lower integer) teams in each group are qualified for the playoffs.

If eight is not a multiple of the number of groups  $m$ , then wildcard games may be played to determine the teams for remaining spots in the playoffs. Details will be announced prior to the tournament.

### CR 3.5 Playoffs

The playoffs consist of quarter finals, half finals, and finals matches. Every playoff round is decided by a single match (best-of-one).

If playoff matches end in a draw after regular match time, they must be decided by playing a penalty shoot-out.

If playoff matches are still drawn after a penalty shoot-out, the penalty shoot-out will be repeated and after another draw the match will be decided by a toss.

A plan of playoff matches will be made available by the organizing committee before start of the tournament.

**CR 3.6 Appearance at game start**

If a team does not show up at the beginning of a game, a victory will be awarded to the opponent team with a score of 3-0.

**CR 3.7 Withdrawal from game**

If a team withdraws from a game after it started, a victory will be awarded to the opponent team, either by adding three goals to its current score, or by adding the necessary number of goals to ensure a minimum difference of three goals.

**COMPETITION RULE 4 - Summary of Object Colorings**

Here is the list of colors for objects on the field (surface, wall, goals, and ball):

<b>Object</b>	<b>Color</b>
Field surface	GREEN
Field safety boundary	GREEN or BLACK
Lines on the field	WHITE
Ball	ORANGE
Robot bodies	BLACK
Markers of robots for team A	LIGHT BLUE
Markers of robots for team B	MAGENTA/PURPLE

Colors of the objects are defined by RAL colors for a moment as shown in

- <http://www.er.ams.eng.osaka-u.ac.jp/user/yasutake/RoboCup/ralcolors.jpg>
- <http://www.er.ams.eng.osaka-u.ac.jp/user/yasutake/RoboCup/ralcolors2.jpg>

All you need to know about RAL you will find under <http://www.ral.de/farben/en/index.html> Color cards you will find in any well equipped paint shop.

**COMPETITION RULE 5 - Referee Box**

The official referee box is available at

- <http://sourceforge.net/projects/msl-refbox>

It is mandatory for all teams to use this referee box.

**COMPETITION RULE 6 - Rules Updating Time Out**

If the TC doesn't provide updated rules for the next tournament until Nov, 1st, the existing rules of the last tournament will apply.

# Chapter

## F-2000 Challenges

Challenges 4 AND 6 have been selected by the TC for RoboCup-2009 as mandatory. (This means each team has to perform in two challenges.) All teams are expected to participate in the challenge competition. Teams not participating in the tournament are welcome to participate in the challenge competition. The winner of the challenge competition will be awarded a prize for technical achievements.

All other challenges are currently regarded as proposals. All teams are invited to contribute their ideas in order to add new challenges or further improve existing challenges.

### Challenge 1 - Ball Control and Planning

Five to eight black obstacles (length/width 40 cm, height 60 cm) are put at arbitrary positions on the field. The ball is put on the middle of the penalty area line, and a robot inside the same goal. The robot should dribble the ball into the opposite goal within 90 seconds, while it avoids all obstacles. One point is awarded to the robot if the ball has passed the center line, another point when a goal is scored. Penalty points are given each time the robot or the ball touches an obstacle. The challenge is repeated three times with various setups. An extra point is awarded to the team with the fastest robot. In order to be eligible for this extra point the robot may not have touched any of the obstacles. In total a team can be awarded up to seven points for this challenge.

### Challenge 2 - Cooperative behavior

Teams should demonstrate cooperative behavior between at least two robots. The selection of the activity to be performed is free, but it should last at most 90 seconds. A jury will evaluate the quality of cooperation and cooperative behavior and will assign up to six points to each team.

### Challenge 3 - Cooperative Mixed-Team Play

Teams should demonstrate cooperative mixed-team play between at least two robots from different teams. The selection of the activity to be performed is free, but it should last at most 90 seconds. A jury will evaluate the quality of cooperation and cooperative behavior and will assign up to six points to each team.

### Challenge 4 - Play with an arbitrary FIFA ball

The aim of this challenge is to encourage teams to improve their vision routines. This challenge is carried out with three different standard FIFA balls. A robot is placed on the field and the ball is placed in front of the robot for 5 seconds. Afterwards the ball is placed at an arbitrary position on the field. The robot has now 60 seconds to find the ball and to dribble it into a predefined goal. One point is awarded to the robot for correctly identifying the ball, i.e. the robot has found and touched the ball for the first time. A second point is awarded if the robot has scored a goal. In total this challenge is repeated three times with varying balls but always with the same robot. In total a team can be awarded up to six points for this challenge.

## Challenge 5 - Play on an outside field

This challenge will only be offered, if it is possible by the organizers to provide a suitable field with respect to the actual field standards. Nevertheless, it is every time possible for teams to prepare by themselves an outside field of their choice which can also be smaller than the regular one. The team should be able to show solutions for typical problems on an outside field. To present these solutions it's not necessary to demonstrate them on a full size field, therefore a minimum field size is set to 10m×8m. If a team prepares a field by their own, even the type of ground can be selected by them, provided that it is the original type of ground of the chosen area, e.g. concrete, artificial turf, etc.

Teams that want to perform in this challenge have to contact the organizing or technical committee as soon as possible, because the resulting scenario needs to be approved by the technical committee.

Each of the above mentioned four abilities can be awarded with 2 points:

- The robots have to present that they are able to handle the ball according to the structure of the ground of the field.
- The robot has to approach a ball over distances of 2, 4, 6 and 8 meters.
- The robot has to avoid 3 obstacles.
- Summary of the above: The robot has to approach the ball over a distance of approx. 4m, then it has to score a goal after crossing a distance of approx. 6m, avoiding 3 randomly placed obstacles on the field and one obstacle in the goal.

A team has six minutes to demonstrate these abilities of their robots.

## Challenge 6 - Show scientific or engineering achievements

Teams are free to show one significant achievement each, and all the other team leaders, together with the TC members will judge them. Achievements in the present list are encouraged.

## Challenge 7 - Passing

At the beginning, the ball is on the own penalty kick point. A player (#1) is on the center point. Another player (#2) is in the opposite half field. A still goalie (a black box, 50 cm wide) is in the middle of the opponent goal. Player #1 has to get the ball, pass it to player #2 which should score the goal. 1 point if the ball passes midline, 1 point if it is dribbled by player #1 over midline, 3 points if it hits player #2, 3 points if player #2 tries to score in the opponent goal (either by kicking or bringing the ball there, always following the rules), 2 points if the goal is scored. Time is also taken and used to rate the teams in case of same number of points.





# Appendix

## Tables

### A 1 Table of Network-Addresses

General Setup:

- WEP encryption is turned off.
- Broadcast of SSID is turned on.
- Subnet mask normal PC: 255.255.255.0.
- Subnet mask of a PC connected to the Refbox: 255.255.0.0.
- Access Point Beacon Interval should be set to 20-30.
- Access Point DTIM Interval should be set to 2-3.

Organization - Network Setup:

	Field A	Field B	Field C	Field D
SSID	MSL FIELD A	MSL FIELD B	MSL FIELD C	MSL FIELD D
Switch	172.16.1.1	172.16.2.1	172.16.3.1	172.16.4.1
Referee Box	172.16.1.2	172.16.2.2	172.16.3.2	172.16.4.2
Access Point 1 (802.11b)	172.16.1.3	172.16.2.3	172.16.3.3	172.16.4.3
Access Point 2 (802.11a)	172.16.1.4	172.16.2.4	172.16.3.4	172.16.4.4

Team - Network Setup for unicast communication:

Address	Team	Address	Team
172.16.32.*	Organization	172.16.54.*	Paderkicker
172.16.33.*	5dpo-2000	172.16.55.*	Persian Gulf (IAUT)
172.16.34.*	AIS/BIT Robots	172.16.56.*	Philips Robocup Team
172.16.35.*	AllemaniACs	172.16.57.*	The Orient
172.16.36.*	Team Aros	172.16.58.*	Osaka University Trackies
172.16.37.*	Attempto Tubingen	172.16.59.*	Robofoot EPM
172.16.38.*	Brainstormers Tribots	172.16.60.*	Satrap
172.16.39.*	CAMBADA	172.16.61.*	Smoking Jays
172.16.40.*	Carpe Noctem	172.16.62.*	Su-Spada
172.16.41.*	CoPS Stuttgart	172.16.63.*	Tech United Eindhoven
172.16.42.*	EIGEN	172.16.64.*	TKU-ITRI
172.16.43.*	FU-Fighters	172.16.65.*	Ulm Sparrows
172.16.44.*	Hibikino-Musashi	172.16.66.*	WinKIT
172.16.45.*	ISePorto	172.16.67.*	
172.16.46.*	ISocRob MSL	172.16.68.*	
172.16.47.*	Jiao Long	172.16.69.*	
172.16.48.*	Khorasgan University	172.16.70.*	
172.16.49.*	MINHO	172.16.71.*	
172.16.50.*	Mostly Harmless	172.16.72.*	
172.16.51.*	MRL	172.16.73.*	
172.16.52.*	MRT - Milan Robocup Team	172.16.74.*	
172.16.53.*	NuBot	172.16.75.*	

Team - Network Setup for multicast IPv4 communication:

Address	Team	Address	Team
224.16.32.32	Organization	224.16.32.54	Paderkicker
224.16.32.33	5dpo-2000	224.16.32.55	Persian Gulf (IAUT)
224.16.32.34	AIS/BIT Robots	224.16.32.56	Philips Robocup Team
224.16.32.35	AllemaniACs	224.16.32.57	The Orient
224.16.32.36	Team Aros	224.16.32.58	Osaka University Trackies
224.16.32.37	Attempto Tubingen	224.16.32.59	Robofoot EPM
224.16.32.38	Brainstormers Tribots	224.16.32.60	Satrap
224.16.32.39	CAMBADA	224.16.32.61	Smoking Jays
224.16.32.40	Carpe Noctem	224.16.32.62	Su-Spada
224.16.32.41	CoPS Stuttgart	224.16.32.63	Tech United Eindhoven
224.16.32.42	EIGEN	224.16.32.64	TKU-ITRI
224.16.32.43	FU-Fighters	224.16.32.65	Ulm Sparrows
224.16.32.44	Hibikino-Musashi	224.16.32.66	WinKIT
224.16.32.45	ISePorto	224.16.32.67	
224.16.32.46	ISocRob MSL	224.16.32.68	
224.16.32.47	Jiao Long	224.16.32.69	
224.16.32.48	Khorasgan University	224.16.32.70	
224.16.32.49	MINHO	224.16.32.71	
224.16.32.50	Mostly Harmless	224.16.32.72	
224.16.32.51	MRL	224.16.32.73	
224.16.32.52	MRT - Milan Robocup Team	224.16.32.74	
224.16.32.53	NuBot	224.16.32.75	